

NATURAL  
  
COOL



## VYSOKOTLAKOVÉ ČERPADLÁ HIGH PRESSURE PUMPS

BETTER PERFECT  
THAN CHEAP.



## ZAHMLIEVACÍ SYSTÉM

VODNÁ HMLA - ADIABATICKÉ CHLADENIE

## MISTING SYSTEMS

ADIABATIC ATOMIZATION & ADIABATIC COOLING

2025

[www.imtec.sk](http://www.imtec.sk)

# ABOUT US

**THE ONLY WAY  
TO DO GREAT  
WORK  
IS TO LOVE  
WHAT YOU DO.**

Natural Cool division, with their decade of experience in the sector of equipment for misting pumps, is one of the leading companies on the national and international market for the manufacture of adiabatic systems .

Production is organised totally on their premises, giving the end product a total guarantee of quality, starting from raw materials and ending with a personalised and unique test of each model.

These characteristics allow Natural Cool division to co-operate clearly with their clients, not just as a normal supplier but as an ideal and flexible partner in receiving requests and giving answers.

In this dimension the company has recently launched their technical and commercial structure, above all in human resources, which are Natural Cool's strong point.



## PAGE OF CONTENTS

[15](#) • APPLICATIONS

---

[34](#) • SPRAY

---

[36](#) • SPRAY ADVANCE

---

[38](#) • PROFY ADVANCE

---

[40](#) • MISTY ADVANCE

---

[42](#) • FOGGY ADVANCE

---

[44](#) • HPRO

---

[46](#) • HPRO VFD

---

[48](#) • HPRO MZ

---

[50](#) • AXA PUMP

---

[52](#) • AXA PUMP VFD

---

[54](#) • RO SYSTEM

---

[56](#) • FANS

---

## ADVANCE FEATURES

---

Natural Cool misting systems combine reliability and cleaning efficiency to achieve the maximum cooling power possible per horsepower – saving money, time, and water. Our range of misting systems use an advanced wobble-plate pump producing greater pressure and flow rate. The simple, rugged design insures reliability. The pump is so durable it is capable of running dry, or in bypass, for an extended period of time without damage.



# ADIABATIC COOLING SYSTEM

EVAPORATIVE COOLING IS RESPONSIBLE FOR THE CHILL YOU FEEL WHEN A BREEZE STRIKES YOUR SKIN. THE AIR EVAPORATES THE WATER ON YOUR SKIN, WITH YOUR BODY HEAT PROVIDING THE ENERGY.

BY FORCING WATER, BY MEANS OF A HIGH PRESSURE PUMP, THROUGH OUR SPECIALLY DESIGNED MISTING NOZZLES, WE CREATE A FOG OF ULTRA FINE WATER DROPLETS WITH AN AVERAGE SIZE OF LESS THAN 10 MICRONS.

THESE TINY WATER DROPLETS QUICKLY ABSORB THE ENERGY (HEAT) PRESENT IN THE ENVIRONMENT AND EVAPORATE, BECOMING WATER VAPOR (GAS). THE ENERGY (HEAT) USED TO CHANGE THE WATER TO GAS IS ELIMINATED FROM THE ENVIRONMENT, HENCE THE AIR IS COOLED.

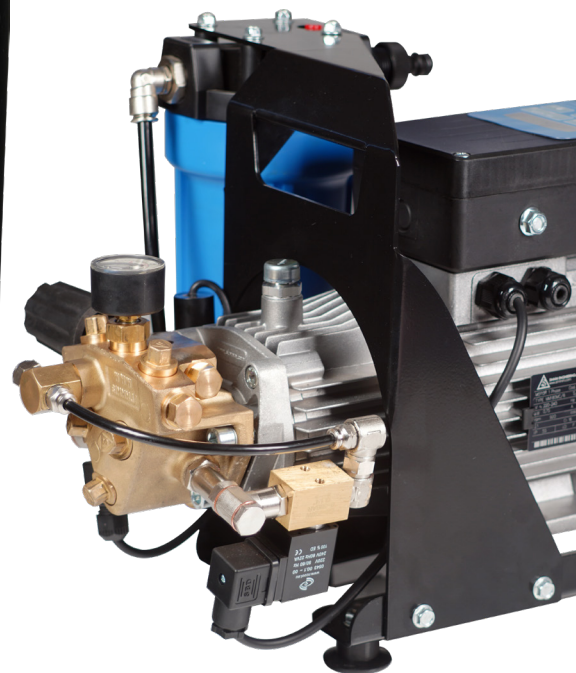
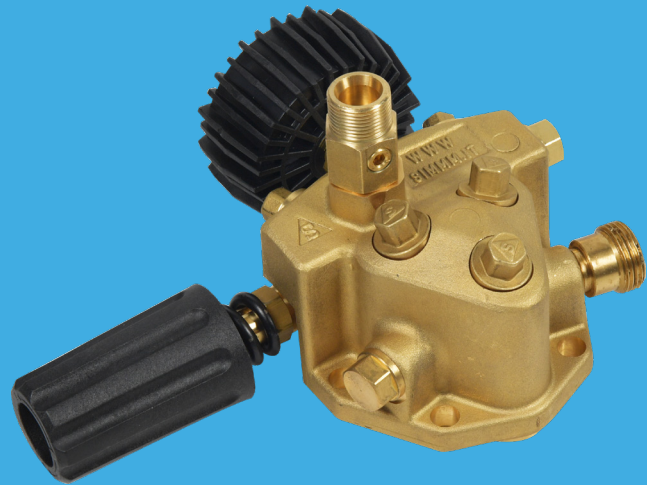
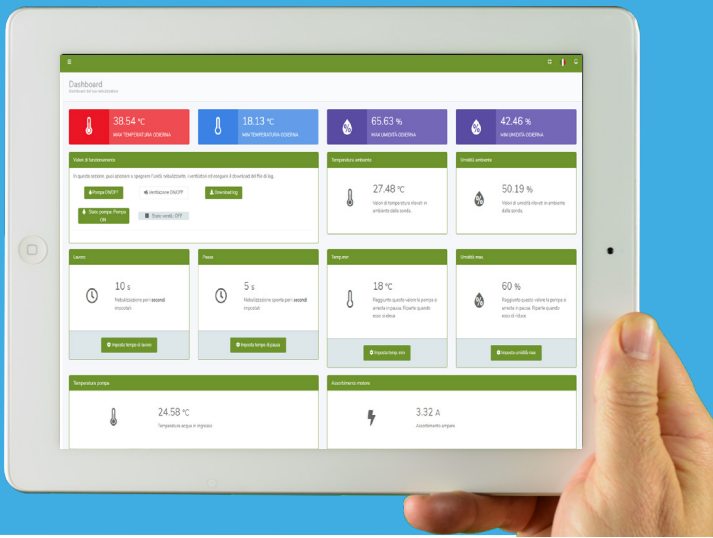



# HUMIDIFICATION

OUR SYSTEMS ARE THE MOST EFFICIENT SOLUTION TO KEEP THE RIGHT HUMIDITY LEVELS OF MATERIALS AND OF PROCESSES. DIFFERENT LEVELS OF RELATIVE HUMIDITY PROVIDES ADEQUATE MOISTURE CONTENT IN ALL HYGROSCOPIC MATERIALS. MOISTURE CONTENT REQUIREMENTS VARY GREATLY FROM ONE MATERIAL TO THE NEXT. THIS TABLE SHOWS TYPICAL HYGROSCOPIC MATERIALS WHICH REQUIRE SPECIFIC RH LEVELS TO AVOID MOISTURE LOSS AND MATERIALS DETERIORATION AND/OR PRODUCTION PROBLEMS.



# INNOVATION AND DESIGN

WHEN USING ADIABATIC SYSTEMS NOT ONLY IS ATOMISATION OF FUNDAMENTAL IMPORTANCE, BUT THE CONTROL OF THE FLOW OF WATER MOLECULES AS WELL. FOR THIS REASON NATURAL COOL HAS DEVELOPED AN INTEGRATED DIGITAL CONTROL SYSTEM THAT ALLOWS THE MANAGEMENT OF MULTIPLE FEATURES SIMULTANEOUSLY. PRECISION THERMOHYGROMETRIC MANAGEMENT, COMBINED WITH A DIGITAL TIMER, ALLOWS THE DELIVERY OF CORRECT QUANTITIES IN ANY ENVIRONMENTAL CONDITION IN ACCORDANCE WITH THE PRECISE CHOICES OF THE USER, SUCH AS TEMPERATURE, WATER SUPPLY AND OPERATING PRESSURE, AND PRESERVES THE LONGEVITY AND OPERATIONAL QUALITY. THE DISPLAY ALSO ALLOWS THE READING OF OTHER NECESSARY INFORMATION SUCH AS PERIODIC CHECK-UPS, TEMPERATURE AND RELATIVE HUMIDITY IN THE ROOM, AND THE SET PARAMETERS. IT IS POSSIBLE TO SEE AND RAPIDLY MODIFY THE PARAMETERS FOR THE IDLING AND WORKING TIMES OF THE HIGH PRESSURE MISTING MODULE, SO AS TO BE ABLE TO ADAPT ATOMISATION TO THE CHANGING NEEDS OF THE DAY. THE QUALITIES OF A SUPERIOR MECHANISM MEANS ARE NOTHING WITHOUT AN ADVANCED CONTROL SYSTEM. **NATURAL COOL** IS THE ONLY COMPANY IN THE MARKET, TODAY, THAT PRODUCES SUCH DEDICATED DIGITAL CONTROL SYSTEM, WITHOUT RESORTING TO EXTERNAL ACCESSORIES WHICH HAVE BEEN CREATED FOR DIFFERENT NEEDS.

AXA PUMP CAN WORK WITH 75 °C INLET WATER AS STANDARD FEATURE



VIDEO

## WEB INTERFACE

OUR ATOMIZING CONTROL UNITS ARE THE FIRST ON THE MARKET TO BE “ALWAYS ON” OR, IN OTHER WORDS, CONNECTED TO A LOCAL NETWORK AND THE INTRANET BOTH THROUGH A DEDICATED CABLE OR WI-FI VIA A WIRELESS ROUTER.

IMAGINE THE POSSIBILITY OF SEEING THE OPERATIONAL PARAMETERS IN REAL TIME A VIA A TABLET, PC OR SMARTPHONE, AND CHANGING OR UPDATING THEM ACCORDING TO CUSTOMER NEEDS.

IN ADDITION, PLANT DIAGNOSIS AND REMEDIAL ACTION CAN BE CARRIED OUT REMOTELY WITH A SUBSTANTIAL REDUCTION IN COSTS AND HIGHER PROFITABILITY.

- FULL CONTROL FROM ANY SMARTPHONE TABLET,COMPUTER. (NO APP NEEDS)
- WARNING ALARMS AND NOTIFICATIONS BY EMAIL.
- EASY MAINTENANCE E REMOTE
- SUPPORT SAVING COSTS AND INCREASING EFFICIENCY.
- FRIENDLY USER INTERFACE
- DATA REPORT AVAILABLE WITH CONFIGURATION LOG FILE WITH 6 MONTS DATA RECORDS
- MULTI PLATFORM - NOT APP NEEDS
- REMOTE ACCESS



# ONE TECHNOLOGY MANY SOLUTIONS WHOEVER YOU ARE.

## SIMMM PUMPS AND ELECTRONIC CONTROLS

FEATURING NUMEROUS PARAMETERS AND AN USER-FRIENDLY DISPLAY, THE EDDY5 CONTROLLER ALLOWS PRECISE SETTING OF PUMP PERFORMANCE. THANKS TO THE HIGH NUMBER OF AVAILABLE VARIABLES IT IS POSSIBLE TO PERSONALIZE PUMP FUNCTIONING ON THE BASIS OF CUSTOMER REQUIREMENTS.



- SIMMM PUMP AXA MODEL WITH NO OVERHEATING SYSTEM
- PATENTED FLOW RATE VALVE (LARGE RANGE OF NOZZLE NUMBERS WITH THE SAME MODEL)
- MAX WORKING PRESSURE UP TO 105 BAR
- PROFESSIONAL GAUGE
- SAFETY WATER PRESSURE SWITCH
- HIGH PRESSURE RELEASE SOLENOID VALVE
- "H" CLASS MOTOR WITH LOW MOTOR SPEED (900 RPM)
- THERMAL PROTECTION
- LOWEST NOISE LEVEL 50 DB
- LOW VOLTAGE CONTROL PANEL (12 VOLT)
- RADIO REMOTE CONTROL
- DIGITAL CYCLING TIMER
- DIGITAL WATER LITER COUNTER
- DIGITAL PRESSURE READER
- TEMPERATURE AND HUMIDITY PROGRAM
- SELF-DIAGNOSIS
- SOFT TOUCH PANEL
- STAINLESS STEEL CABINET (HPRO MODEL)
- INTEGRATED DRAIN SYSTEM
- ANTI-LEGIONELLA PNEUMOPHILA AUTOMATIC SYSTEM E
- BUILT-IN COOLING FANS (HPRO MODELS)
- MULTIPLY REMOTE CONTROL PANELS OVER IP ETHERNET CONNECTIONS
- FIRMWARE UPDATE
- DATALOGGER BUILT-IN ABOUT ALL THE PUMP PARAMETERS
- REMOTE ACCESS CAPABILITY: FROM ANY TABLET, COMPUTER IS POSSIBLE MANAGE THE PUMPS EVERYWHERE
- MODBUSRS485(BMS)COMUNICACIONPROTOCOLS AS STANDARD

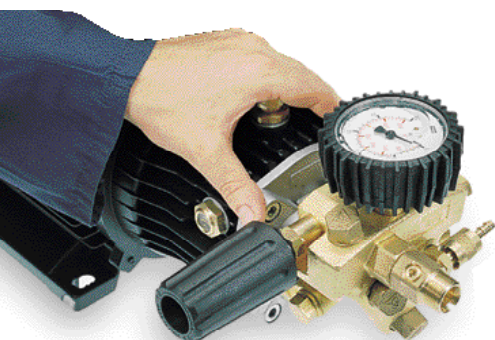

## PUMPS MADE IN HOUSE

## SIMMM PUMP A STEP AHEAD

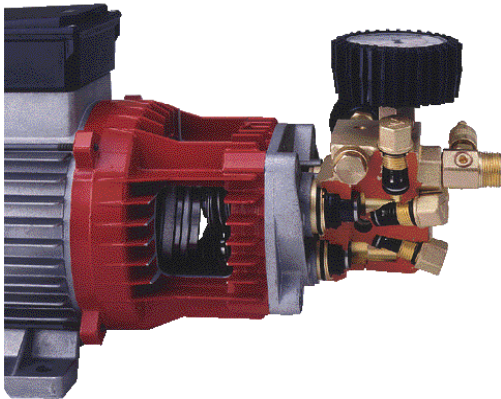

AXA SIMMM PISTON PUMP WITH DOUBLE WATER SEALS AND COATED PISTON FOR THE BEST PERFORMANCE  
NATURAL COOL MISTING PUMPS USE AN ADVANCED ITALIAN WOBBLE-PLATE PUMP PRODUCING MORE PRESSURE AND FLOW RATE THAN A CRANK CASE PUMP. THE SIMPLE, RUGGED DESIGN INSURES RELIABILITY. THE SIMMM PUMP IS SO DURABLE IT IS CAPABLE OF RUNNING DRY, ON IN BYPASS, FOR AN EXTENDED PERIOD OF TIME WITHOUT DAMAGE.

SIMMM PUMPS RUN DRY BY USING BACKUP RINGS COMBINED WITH CERAMIC COATED STAINLESS STEEL PLUNGERS TO PROVIDE SUPERIOR HEAT TRANSFER FROM THE PUMP HEAD TO THE OIL BATH.

50dB  
900 rpm

## SILENCE... WE ARE WORKING



INCREDIBLE SOUND LEVEL LESS THAN 50 DB THANKS TO AN HIGH PERFORMANCE ELECTRIC MOTOR RUNNING AT 6 POLES 900 RPM. THE INTERNAL WINDINGS ARE IN "H" CLASS SUITABLE FOR WARM ENVIROMENT.  
EXTREMELLY QUIE BOOTH FOR INDUSTRIAL OR COMMERCIAL APPLICATION.

## EDDY5: A REAL COMPUTER.



MANY PROGRAMS SO FAR OPTIONAL IN THE MARKET MAKE THE USE OF ANY OF OUR PUMP MODELS EASY AND INTUITIVE AND CONTRIBUTE, NOT ONLY TO IMPROVE THE NEBULIZATION BUT GUARANTEE AN UNCOMMON RELIABILITY.  
THE HEART OF EDDY 5 IS A PROCESSOR SO ADVANCED THAT MAKES THE NATURAL COOL ATOMIZING PUMPS SUITABLE TO "TALK" WITH THE WORLD. TWITH THE PUMP, CHECK THE OPERATING STATUS, THE SELECTED PROGRAMS, ALL OPERATIONAL ALARMS AND MUCH MORE.

## COOL APP



COOL APP CAN BE DOWNLOADED FROM THE APPLE STORE AND GOOGLE PLAY AND ALLOWS THE MANAGEMENT OF OUR SPRAY ADVANCE, PROFY ADVANCE, FOGGY ADVANCE AND MISTY ADVANCE MODELS.





## SIMULTANEOUS READING UP TO 4 PROBES

THANKS TO THE DIGITAL TECHNOLOGY IT IS POSSIBLE TO CONNECT UP TO 4 PROBES (TEMPERATURE / HUMIDITY) IN A ROOM WITH A SIMULTANEOUS READING (AVERAGE VALUE) FOR A HOMOGENEOUS HUMIDIFICATION IN INTERNAL AND EXTERNAL PLACES.

A LARGE DISPLAY ALWAYS SHOWS TEMPERATURE AND HUMIDITY IN THE ENVIRONMENT.

THE HUMIDITY AND TEMPERATURE SENSOR IS REPLACEABLE IN CASE OF DAMAGE.



## WEB INTERFACE

A WEB INTERFACE IS AVAILABLE FOR AN EASIER SETUP OF ALL THE PARAMETERS OF THE ATOMIZING PUMP. A WEB INTERFACE IS AVAILABLE FOR AN EASIER SETUP AND MANAGING OF ALL THE PARAMETERS OF THE ATOMIZING PUMP

WEB INTERFACE IS AVAILABLE FROM ANY TABLET OR COMPUTER IN THE SAME LOCAL AREA NETWORK (LAN) BY WIFI

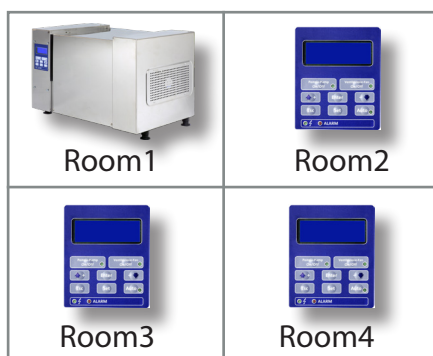

## MULTIPLE CONTROL PANELS

IN CASE OF INSTALLATION OF THE ATOMIZING PUMP IN PLACES NOT EASILY ACCESSIBLE, UP TO 199 REMOTE PANELS CAN BE CONNECTED REMOTELY.

ALL PANELS DISPLAY THE SAME INFORMATION SIMULTANEOUSLY AND SYNCHRONIZED



## BETTER PERFECT... THAN CHEAP

THE AXA PUMP IS SOLD WITH A 10-YEAR GUARANTEE, WHICH CONFERS EXTRAORDINARY RELIABILITY IN EXTREME WORKING CONDITIONS.

THE WARRANTY IS VALID IF MAINTENANCE IS CARRIED OUT REGULARLY AND DOES NOT COVER CONSUMABLES.



## CYCLING TIME PROGRAM

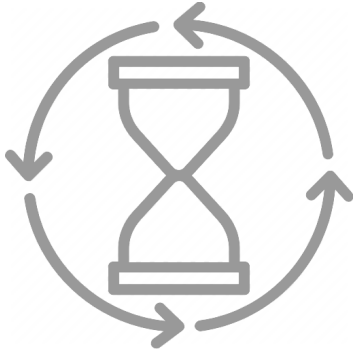

INSIDE THE EDDY5 IS AVAILABLE THE CYCLIC TIMER PROGRAM THAT ALLOWS TO TIMER THE ATOMIZING PUMP GRANTING A PERFECT COMFORT WITHOUT CONDENSATION

## DIGITAL WATER LEAKING ALARM



THIS ALARM IS AVAILABLE IN CASE OF WATER LOSS FROM THE HIGH PRESSURE LINE BY DEFINING A MINIMUM / MAXIMUM PRESSURE VALUE, IT IS ALSO POSSIBLE TO WARN THE USER ABOUT A POSSIBLE OBSTRUCTION OF THE NOZZLES.

## 230 VOLT FAN SOCKET AVAILABLE.



ALL OUR ATOMIZING PUMPS HAVE A SOCKET FOR CONNECTING ONE OR MORE FANS (MAX 10 AMPS) FOR AN AUTOMATIC START WHEN THE PUMP IS SWITCHED ON. THANKS TO THE SUPPLIED RADIO CONTROL, THE FANS CAN BE SWITCHED ON SEPARATELY OR CONTROLLED BY REMOTE ACCESS CLOUD SERVICE

## INTERNAL DRAIN VALVE WITH ADJUSTABLE TIME



THIS DEVICE ALLOWS THE DRAINAGE OF HIGH PRESSURE WATER INTO THE PIPES. THROUGH A SPECIAL VALVE THE DRAIN IS INTERNAL AND NOT EXTERNAL AS FOR THE TRADITIONAL PUMPS ON THE MARKET. THIS IMPORTANT FEATURE GRANTS A SIMPLE AND EASY INSTALLATION.



## DIGITAL OPERATING ALARMS VIA EMAIL

THE FOLLOWING OPERATIONAL ALARMS ARE AVAILABLE ON THE ALPHANUMERIC DISPLAY AND ARE SENT VIA EMAIL IF THIS FUNCTION IS ENABLED.

- WATER LOSS
- OVER PRESSURE
- OVER AMPS
- OVER HEATING
- MAINTENANCE WITH EVENT DESCRIPTION (OIL CHANGE, NOZZLE CLEANING ETC)
- WATER LEAKING



## WEEKLY PROGRAM

WEEKLY PROGRAM ALLOWS TO SET A TIME FOR SWITCHING THE PUMP ON AND OFF FOR EVERY DAY OF THE WEEK. TWO DAILY SLOTS GUARANTEE MAXIMUM FLEXIBILITY



## AUTOMATIC WASHING LINE

THANKS TO THE "AUTOMATIC WASHING" PROGRAM THE HIGH PRESSURE LINES ARE AUTOMATICALLY SANITIZED WHENEVER THE DANGER OF BACTERIA SUCH AS LEGIONELLA COULD ARISE.

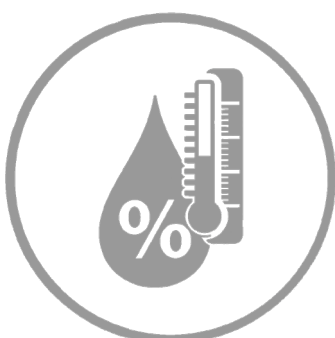

## 4 AUTO PROGRAMS

THANKS TO THE SOPHISTICATED EDDY5 PROCESSOR AND TO THE "AUTO PROGRAM" THE ATOMIZING PUMP CAN ALWAYS AUTOMATICALLY DOSE THE CORRECT AMOUNT OF WATER FOR PROPER COOLING AND SUITABLE HUMIDIFICATION ACCORDING TO THE AMBIENT TEMPERATURE,



## DIGITAL PRESSURE AND FLOW RATE MEETERS

ON THE LARGE DISPLAY IS ALWAYS DISPLAYED IN REAL TIME THE PRESSURE AND CONSUMPTION OF WATER SO YOU CAN ALWAYS CHECK THE CORRECT OPERATION OF THE PUMP. SOPHISTICATED ALARMS CAN BE ACTIVATED IN CASE OF LOW / HIGH PRESSURE AND FLOW RATE.

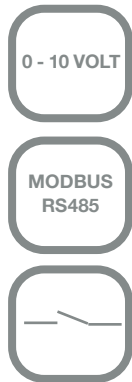
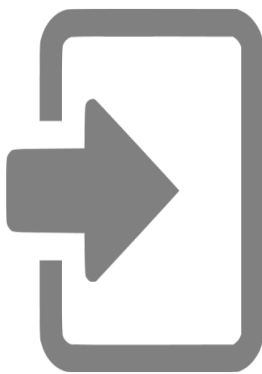

### INPUT OPTIONS

THE EDDY5 ELECTRONIC BOARD CAN BE MANAGED BY VARIOUS EXTERNAL DEVICES USING DIFFERENT INPUTS:

- MODBUS (SLAVE) RS485 COMMUNICATION PROTOCOL (BMS)
- 0-10 VOLTS
- REMOTE CONTACT ON / OFF

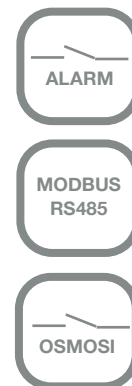
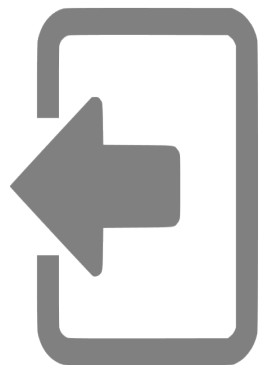

### OUTPUT OPTIONS

THE EDDY5 ELECTRONIC BOARD HAVE MULTIPLY OUTPUT CONNECTIONS FOR VARIOUS DEVICES AND FUNCTIONS:

- MODBUS (MASTER) RS485 COMMUNICATION PROTOCOL (BMS)
- REMOTE CONTACT FOR ALARM SIGNALS AS LIGHT, SIREN ETC...
- RO SYSTEMS

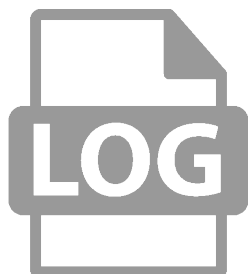

### DATALOGGER FOR EVENT RECORDS

THE ATOMIZING PUMPS WITH ELECTRONIC BOARD EDDY5 RECORD IN REAL TIME ALL THE SETTINGS, THE SET POINTS, THE VALUES OF AMBIENT HUMIDITY, THE ELECTRICAL ABSORPTION, THE ALARMS ETC ... AND BE ABLE TO DOWNLOAD THEM VIA USB PORT FOR A SUBSEQUENT CONSULTATION. USEFUL FUNCTION IN CASE OF VERIFICATION OF THE WORKING CONDITIONS OF THE PUMP.

## FIRMWARE UPDATE BY USB

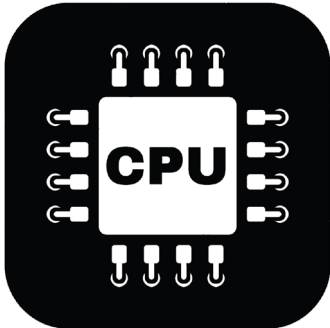

THE EDDY5 ELECTRONIC BOARD IS NEVER “OLD”. THANKS TO FIRMWARE RELEASED PERIODICALLY WITH NEW UPDATES AND PROGRAMS MAKE THE NATURALCOOL PUMPS ALWAYS UP-TO-DATE AND SUITABLE FOR EVERY NEED

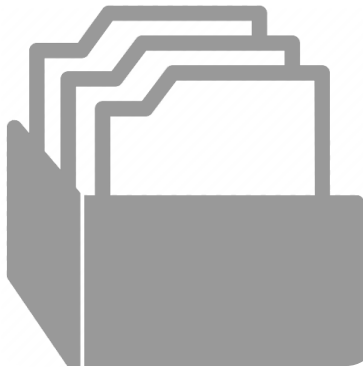

## ALARMS RECORDS

THE LAST 10 ALARMS ARE RECORDED FOR QUICK REFERENCE AND CHECK THE WORKING CONDITIONS OF THE PUMP.



## ONLINE MONITORING CHILLER

THE EDDY5 CONTROL PANEL ALLOWS THE MONITORING OF THE ELECTRICAL ABSORPTION OF THE CONDENSING UNITS, SHOWING THE BENEFITS OF PRECCOLING TO REDUCE THE ELECTRICAL LOAD. THROUGH A USB PORT IT IS POSSIBLE TO CHECK AND DOWNLOAD THE LOG FILE WITH ALL THE DATA RECORDED BY TIME AND DATE.

# OUTDOOR COOLING FOR PEOPLE

THERE IS A DIRECT, TANGIBLE BENEFIT TO KEEPING GUESTS COMFORTABLE IN A RESORT SETTING. EVERYTHING FROM THE CHECK-IN EXPERIENCE TO THE CHECK OUT PROCESS IS METICULOUSLY ANALYZED AND ADDRESSED BY HOTELIERS. WITH A FOCUS ON GUEST COMFORT, IT IS NOT SURPRISING TO FIND THAT RESORTS AND HOTELS ARE EMBRACING NATURAL COOL OUTDOOR COOLING SOLUTIONS AS AN INTEGRAL PART OF THE GUEST EXPERIENCE. CREATING A COOL, COMFORTABLE ENVIRONMENT IN DINING AREAS, OUTDOOR LOUNGING AND POOLSIDE AREAS IS PARAMOUNT TO THE OVERALL EXPERIENCE.

ONE OF THE MOST OBVIOUS USES FOR MISTING SYSTEMS IS ALSO IN RESTAURANT DINING AREAS. WHEN TABLES ARE FULL, RESTAURANTS THRIVE. EXTENDING DINING AREAS FROM INDOORS TO OUTDOORS DURING WARMER PERIODS ALLOWS RESTAURANTS AND OTHER FOOD SERVICES TO MAINTAIN A STEADY REVENUE BASE THAT IS LESS SEASONAL IN NATURE. ADDING IN RESTAURANT MISTING SYSTEMS IS A GREAT WAY TO ACCOMPLISH THIS GOAL.



## HOW IT WORKS

A HIGH-PRESSURE MISTING SYSTEM IS ONE OF THE MOST EFFECTIVE AND EFFICIENT METHODS FOR COOLING OUTDOOR PATIOS. THE PROCESS IS THIS: OPERATING AT PRESSURES OF 70 BAR NATURAL COOL PRODUCES MICRON-SIZED WATER DROPLETS THAT, WHILE EVAPORATING AND TURNING TO VAPOR, REMOVES HEAT FROM THE AIR, COOLING THE SURROUNDING AREA.

THE DRY FOG PRODUCED BY A NATURAL COOL SYSTEM REDUCES OUTDOOR TEMPERATURES BY AS MUCH AS 10°C, WHICH MAKES DAYS MORE COMFORTABLE. THIS ENSURES THAT OUTDOOR METER SQUARE IS UTILIZED AND PRODUCING REVENUE.

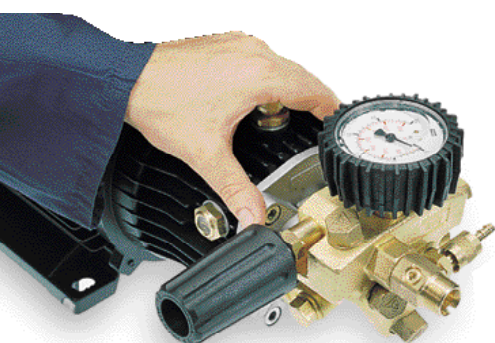

**PUMPS MADE IN HOUSE**



VIDEO



# ONE TECHNOLOGY MANY SOLUTIONS WHOEVER YOU ARE.

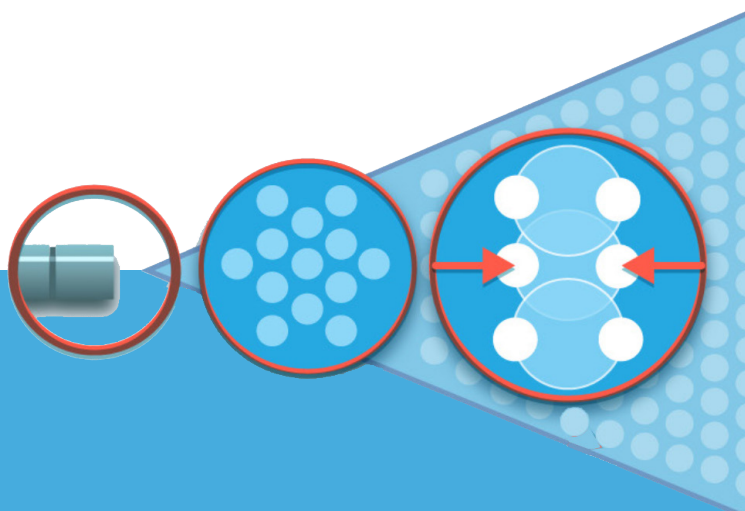

**WATER IS FORCED AT HIGH PRESSURE THROUGH SPECIALIZED NOZZLES**

**NATURAL COOL PRODUCES MICRO-SIZED WATER DROPLETS WHICH ARE SIZED FOR EVAPORATION**

**AS MILLION OF DROPLETS EVAPORATE, THE AIR TEMPERATURE DROPS SIGNIFICANTLY**

# OUTDOOR COOLING FOR ANIMALS

HEAT STRESS POSES A SIGNIFICANT RISK TO COWS. RISING TEMPERATURES CAN CAUSE PROBLEMS SUCH AS SUPPRESSED FEED INTAKE AND REPRODUCTIVE STRESS. NATURAL COOL MANAGES HEAT STRESS BY MODERATING TEMPERATURES IN INDOOR AND OUTDOOR DAIRY ENVIRONMENTS USING DURABLE AND EFFECTIVE MISTING SYSTEMS AND ENVIRONMENTAL CONTROLS TO ALLOW FOR COOLING COWS IN DAIRIES.

DAIRY COWS ARE EXTREMELY SENSITIVE TO HEAT STRESS AND EXTREMELY REACTIVE TO THEIR ENVIRONMENT. MAINTAINING YOUR CATTLE'S HEALTH WITHOUT THE COST OF MAJOR DOSES OF ANTIBIOTICS AND LARGE INVESTMENTS OF TIME OR CAPITAL CAN BECOME A CHALLENGE DURING THE WARMER TIMES OF THE YEAR. AS SOON AS A COW'S CORE TEMPERATURE BEGINS TO RISE TOO HIGH OR TOO SUDDENLY, AN ONSLAUGHT OF NEGATIVE PHYSIOLOGICAL AFFECTS CAN BEGIN TO MANIFEST QUICKLY. THIS CAN CAUSE PROBLEMS WITH REPRODUCTION, MILK QUALITY, QUANTITY AND MYRIAD OF OTHER HEALTH PROBLEMS.



- INCREASE EGGS, MILK AND MEAT PRODUCTION
- REDUCE ANIMALS HEAT STRESS
- DUST SUPPRESSION
- ODOR CONTROL



**MORE WEIGHT  
MORE HEALTH  
MORE MILK  
MORE MEAT  
MORE EGGS**

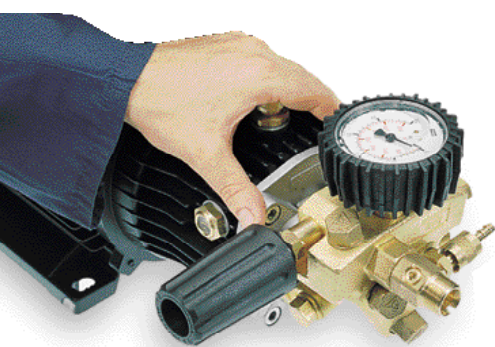

**PUMPS MADE IN HOUSE**



# ONE TECHNOLOGY MANY SOLUTIONS WHOEVER YOU ARE.

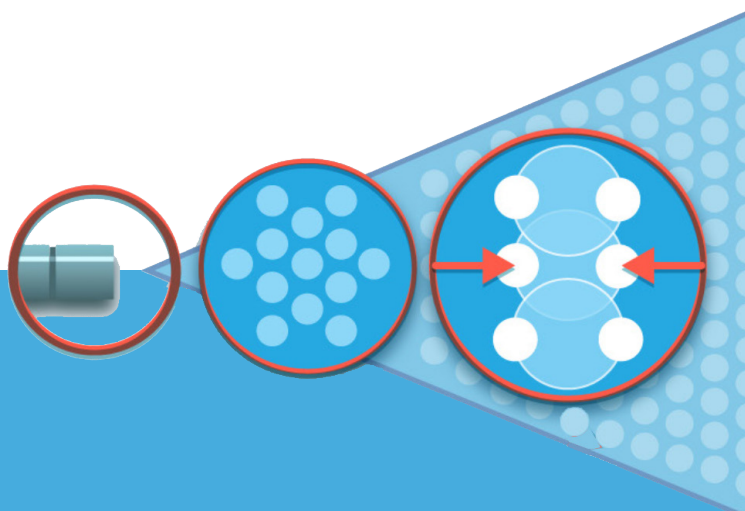

WATER IS FORCED AT HIGH PRESSURE THROUGH SPECIALIZED NOZZLES

NATURAL COOL PRODUCES MICRO-SIZED WATER DROPLETS WHICH ARE SIZED FOR EVAPORATION

AS MILLION OF DROPLETS EVAPORATE, THEIR AIR TEMPERATURE DROPS SIGNIFICANTLY

# SANITATION AND DISINFECTION

A CRITICAL ASPECT TO MAINTAINING A HEALTHY, SAFE ENVIRONMENT FOR CUSTOMERS AND EMPLOYEES.

MAINTAINING A HEALTHY, SAFE ENVIRONMENT FOR CUSTOMERS AND EMPLOYEES REQUIRES AN ECO-FRIENDLY DISINFECTION PLAN TO ELIMINATE PATHOGENS AND MITIGATE RISK. PATHOGENS, COMMON GERMS, AND VIRUSES SPREAD VERY QUICKLY, DISPERSING AND SETTLING ON SURFACES AND HARD-TO-REACH PLACES. TO MINIMIZE THE POSSIBILITY OF INFECTION IN HIGH CONTACT AREAS, AS WELL AS SPACES WHERE GOODS ARE MANUFACTURED, PROCESSED, STORED, OR MOVE BEYOND THE WORKPLACE, A PRECISE, AUTOMATED DISINFECTION PROCESS IS REQUIRED.

EACH NATURAL COOL DISINFECTION FOG SYSTEM IS DESIGNED TO MEET THE NEEDS OF THE APPLICATION AND THE ENVIRONMENT. THE DISINFECTION SYSTEMS ARE HIGHLY SCALABLE AND CAN BE ENGINEERED FOR SMALL TO LARGE SPACES WITH MULTIPLE ZONES. NATURAL COOL INTEGRATES TO EXISTING FACILITY OPERATIONS MANAGEMENT SYSTEMS ALLOWING BUSINESSES AND PUBLIC ENTITIES TO DISINFECT DIFFERENT AREAS AT DIFFERENT TIMES WITH CONSISTENT COVERAGE. WE ALSO OFFER CUSTOM CONTROL SYSTEMS TO ALLOW FOR AUTOMATED DELIVERY WITH SAFETY, SCHEDULING, STAGING AND ZONING REQUIREMENTS.

- SHOPPING MALLS
- FACTORIES AND WAREHOUSES
- LOGISTICS, COURIERS, FREIGHT
- FORWARDERS 3 HOTELS AND RESORTS
- HOSPITALS
- AIRPORTS, BUS AND TRAIN STATIONS
- FOOD PROCESSING INDUSTRY
- EVENTS, BEACHES, SWIMMING POOLS



**EFFECTIVE**  
**99%**  
**REDUCE**  
**BACTERIA**  
**VIRUS (COVID-19)**  
**POLLEN·MITES**  
**SMELLS**

MADE IN ITALY  
FABBRICATO IN ITALIA

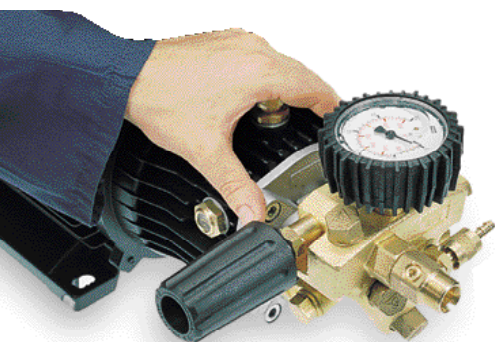

## PUMPS MADE IN HOUSE

# ONE TECHNOLOGY MANY SOLUTIONS WHOEVER YOU ARE.

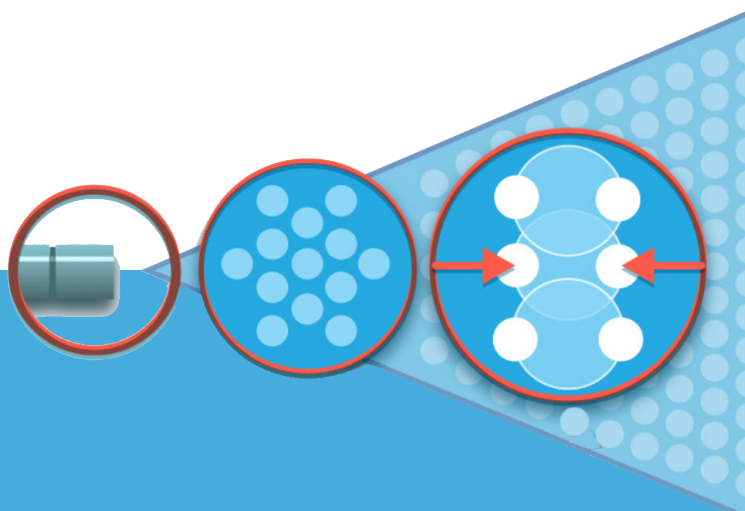

WATER IS FORCED AT HIGH PRESSURE THROUGH SPECIALIZED NOZZLES

NATURAL COOL PRODUCES MICRO-SIZED WATER DROPLETS WHICH ARE SIZED FOR EVAPORATION

AS MILLION OF DROPLETS EVAPORATE, SANITIZING THE ENVIROMENTS



# HUMIDITY CONTROL FOR GREENHOUSES

NATURAL COOLS MISTING SYSTEMS PLAY AN IMPORTANT ROLE IN THE GREENHOUSE CLIMATIC CONTROL. THEY ARE ALSO USED WITH ENORMOUS ADVANTAGES TO KEEP THE RIGHT TEMPERATURE AND HUMIDITY IN THE ENVIRONMENT, UNDER CONDITIONS OF FORCED OR NATURAL VENTILATION.

IN SUMMERTIME THE QUICK EVAPORATION OF THE FOG WILL COOL THE GREENHOUSE DUE TO THE PRINCIPLE OF EVAPORATIVE COOLING, MEANWHILE IT HUMIDIFIES THE ENVIRONMENT IN CASE OF LOW RELATIVE HUMIDITY.

DURING THE WINTERTIME THE SYSTEM KEEPS THE CORRECT HUMIDITY RATE PREVENTING THE DEHYDRATION OF THE CROPS CAUSED BY HEATING SYSTEMS.

THE ENVIRONMENT PRODUCED BY OUR SYSTEM IS APPROPRIATE FOR THE MOST DELICATE CROPS (EX. THE GROWING OF YOUNG SEEDINGS, THE CULTIVATION OF TROPICAL PLANTS AND IN BLOOM PLANTS) WHERE IT IS NOT POSSIBLE TO USE TRADITIONAL SPRAYING METHODS LIKE STANDARD SPRAYING.

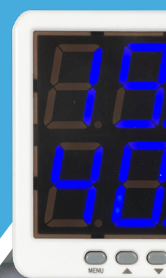

- INCREASED GENERAL PRODUCTIVITY OF THE GREENHOUSE 3 SPEEDS UP PLANTS GROWTH
- KEEPING OF CONSTANT HUMIDITY LEVELS
- LESS HUMIDITY NEED
- THE CORRECT MICRO-CLIMATE IN ANY SEASON
- LOWER WATER CONSUMPTION FOR THE IRRIGATION



NATURAL COOL FOGGING SYSTEM IS AN IDEAL SOLUTION TO APPLY NUTRIENTS, FERTILIZERS ETC AND A PERFECT WAY TO CREATE THE PERFECT ENVIRONMENT.



## PUMPS MADE IN HOUSE

VIDEO



# ONE TECHNOLOGY MANY SOLUTIONS WHOEVER YOU ARE.

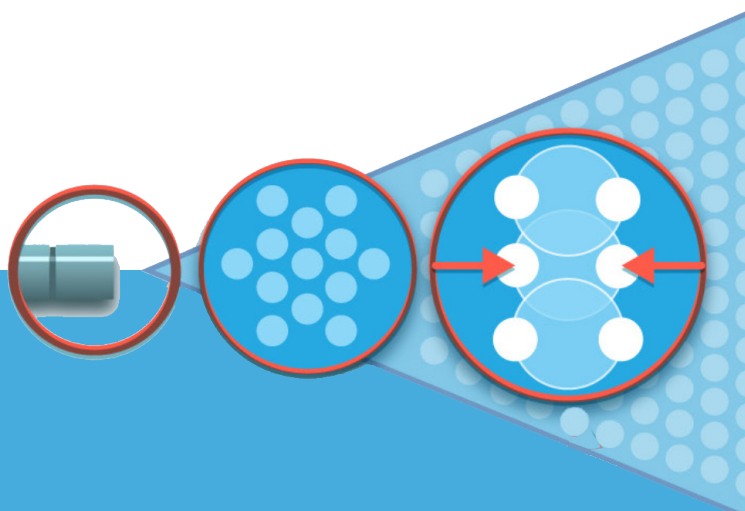

WATER IS FORCED AT HIGH PRESSURE THROUGH SPECIALIZED NOZZLES

NATURAL COOL PRODUCES MICRO-SIZED WATER DROPLETS WHICH ARE SIZED FOR EVAPORATION

AS MILLION OF DROPLETS EVAPORATE, SANITIZING THE ENVIROMENTS

# HUMIDITY CONTROL FOR GOOD WINE

CORRECT HUMIDITY HAS A GREAT IMPACT ON WINE STORAGE IN WOODEN BARRELS AND ON THE PROCESSES IN WINE STORAGE AND AGEING. OPTIMUM AGEING CONDITIONS FOR BARRIQUE WINES ARE FOR INSTANCE PROVIDED AT A CONSTANT TEMPERATURE OF 12 °C AND A RELATIVE HUMIDITY OF 80 %.

WHEN AIR IN THE WINE CELLAR GETS TOO DRY THE WINE CAN DIFFUSE THROUGH THE WOODEN BARRELS EXCESSIVELY. BARRIQUE BARRELS ARE COMPLETELY FILLED AT THE BEGINNING OF THE FERMENTATION. IN THE COURSE OF THE NATURAL MATURATION PROCESS, SOME OF THE WINE EVAPORATES THROUGH THE WOODEN BARRELS. THIS NECESSITATES REFILLING WITH ABOUT 1-2 LITERS/BARREL ON A REGULAR BASIS. ALL YEAR CONSTANT AIR HUMIDITY CAN REDUCE THIS REFILL AMOUNT BY UP TO 0%. ADDED AIR HUMIDIFICATION CAN SAVE TIME AND COSTS DURING WINE STORAGE AND AGEING. PLUS, THE QUALITY OF THE WINES WILL BE SUSTAINABLY AT A HIGHER LEVEL, AS THE REFILL QUANTITIES WILL BE LOWER.



- REDUCES EVAPORATION IN THE WOODEN BARREL
- LOWERS THE MONTHLY REFILL AMOUNTS
- PROTECTS FROM DRYING CRACKS
- PREVENTS LEAKS IN THE WOODEN BARREL
- ENSURES CONSISTENT WINE QUALITY
- PREVENTS CORKS FROM LEAKING AND DRYING OUT



**FULL CONTROL**

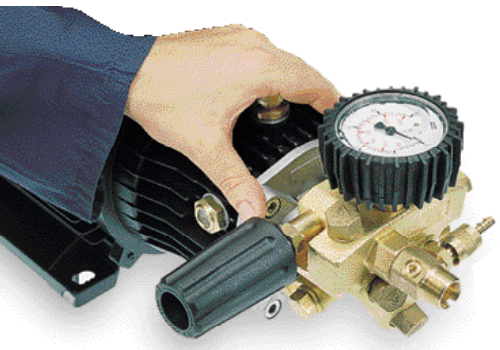

**PUMPS MADE IN HOUSE**



VIDEO



# ONE TECHNOLOGY MANY SOLUTIONS WHOEVER YOU ARE.

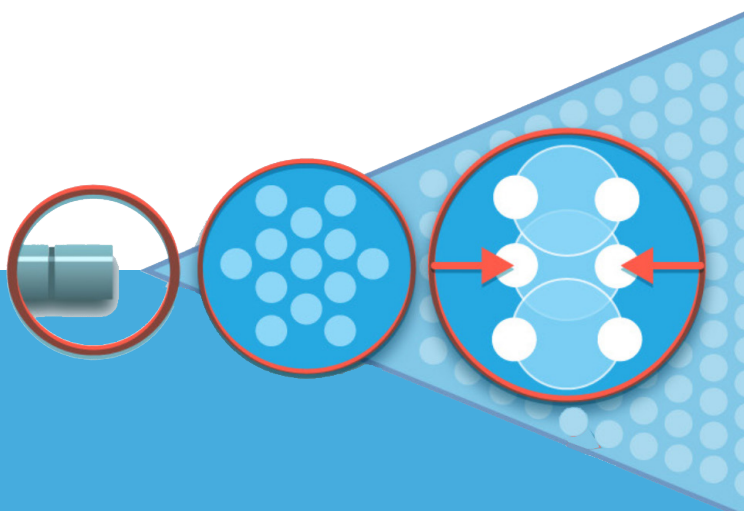

WATER IS FORCED AT HIGH PRESSURE THROUGH SPECIALIZED NOZZLES

NATURAL COOL PRODUCES MICRO-SIZED WATER DROPLETS WHICH ARE SIZED FOR EVAPORATION

AS MILLION OF DROPLETS EVAPORATE, SANITIZING THE ENVIROMENTS

# HUMIDITY CONTROL FOR PAPER

ADDED AIR HUMIDIFICATION HAS SIGNIFICANT IMPORTANCE IN PAPER MANUFACTURING AND IN PAPER PROCESSING PAPER IS A HYGROSCOPIC MATERIAL AND DEPENDING ON THE ENVIRONMENT IT WILL EITHER ABSORB OR RELEASE MOISTURE.

THE PLANT FIBER WILL EITHER SWELL OR SHRINK, DEPENDING ON THE RELATIVE HUMIDITY. WHEN THE HUMIDITY IS TOO LOW THE PAPER WILL WARP TO THE SHAPE OF A "PLATE", IF THE HUMIDITY IS TOO HIGH, THE EDGES WILL "RIPPLE". WITHOUT CONTROLLED HUMIDITY SIGNIFICANT PROBLEMS CAN ARISE DURING PRINTING, CUTTING, IN FURTHER PROCESSING, FINISHING OR DURING THE PRODUCTION OF PACKAGING. DEVIATIONS OF 8% TO 10% IN RELATIVE HUMIDITY IN RELATION TO THE EQUILIBRIUM MOISTURE OF THE PAPER OF 50% ARE CONSIDERED CRITICAL LIMIT VALUES. CONSEQUENCES OF HUMIDITY THAT IS TOO LOW ARE FOR EXAMPLE: DOUBLING, REGISTER DIFFERENCES, WRINKLES

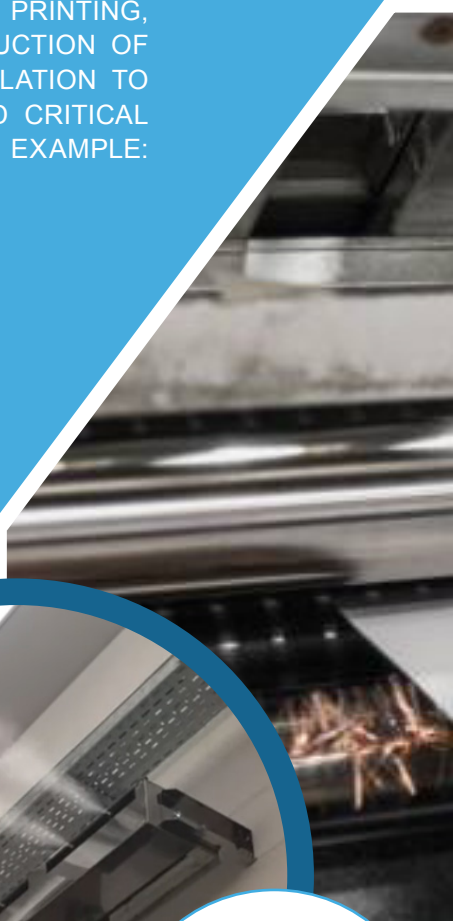

- INCREASE IN OUTPUT SPEED
- REMOVAL OF STATIC ELECTRICITY
- MINIMIZATION OF SCRAPS AND DOWNTIME
- REDUCTION IN CURL AND DEFORMATIONS
- IMPROVEMENT IN QUALITY FOLDING MECHANICAL PROCESS AS REGARDS
- PAPER AND BOARD 3 IMPROVEMENT IN FLEXIBILITY AND DIMENSIONAL STABILITY



**HUMIDITY FANS**

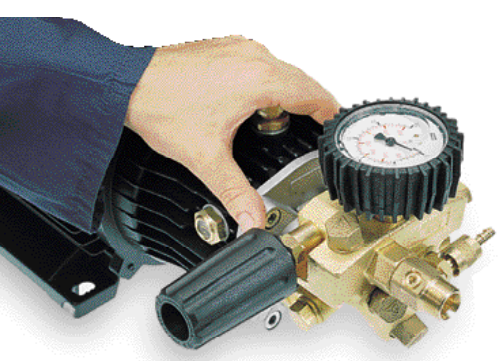

**PUMPS MADE IN HOUSE**



VIDEO



# ONE TECHNOLOGY MANY SOLUTIONS WHOEVER YOU ARE.

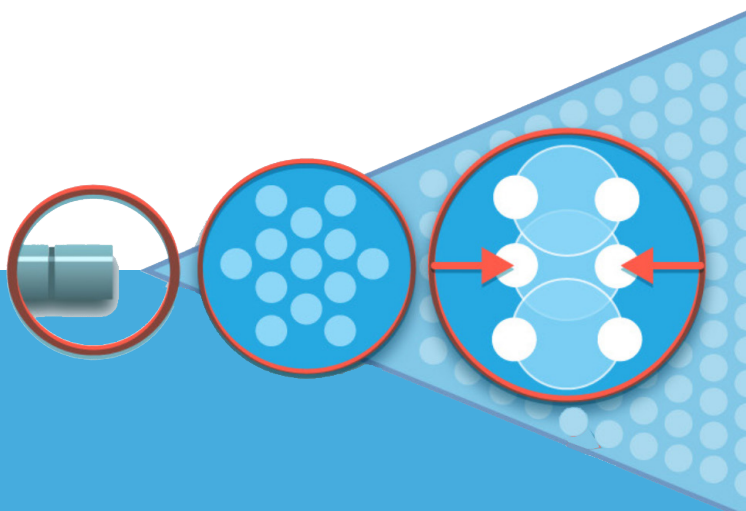

WATER IS FORCED AT HIGH PRESSURE THROUGH SPECIALIZED NOZZLES

NATURAL COOL PRODUCES MICRO-SIZED WATER DROPLETS WHICH ARE SIZED FOR EVAPORATION

AS MILLION OF DROPLETS EVAPORATE, SANITIZING THE ENVIROMENTS

# HUMIDITY CONTROL FOR TEXTILES

AIR HUMIDIFICATION IS PART OF QUALITY ASSURANCE FOR MANY APPLICATIONS IN THE TEXTILE INDUSTRY. YARNS AND TEXTILES REACT QUICKLY TO AIR THAT IS TOO DRY OR TOO HUMID. FIBERS BECOME FRAGILE; FABRICS SHRINK IN LENGTH OR WIDTH OR GET STRETCHED OUT. THIS WILL LOWER THE QUALITY OF SEMI-FINISHED OR FINISHED PRODUCTS AND WILL RESULT IN ADDED COSTS IN THE TEXTILE PRODUCTION.

YARNS AND SEMI-FINISHED PRODUCTS MUST UNTIL FABRIC COMPLETION, OR SOMETIMES EVEN UNTIL THE PRODUCT IS DONE, HAVE THE CORRECT INTRINSIC MOISTURE, WHICH MUST ALSO BE IN EQUILIBRIUM WITH THE RELATIVE HUMIDITY OF THE AMBIENT AIR. IF THE RELATIVE HUMIDITY IS INADEQUATE, THE MATERIALS LOSE ELASTICITY AND TENSILE STRENGTH. FOR EXAMPLE, IT HAS BEEN DEMONSTRATED FOR COTTON PRODUCTS (SOURCE: INSTITUTE OF TEXTILE TECHNOLOGY, USA), THAT AN INCREASE IN RELATIVE HUMIDITY FROM 60% TO 70% BRINGS WITH IT AN ELASTICITY INCREASE OF MORE THAN 15%. LEATHER ALSO RETAINS ITS NATURAL PROPERTIES BY MEANS OF ADEQUATE HUMIDITY AND CAN BE PROCESSED INTO HIGH-QUALITY PRODUCTS.



- PRODUCT WEIGHT
- STATIC CONTROL
- YARN PRODUCT QUALITY
- WEAVING EFFICIENCY
- EMPLOYEE COMFORT



**HUMIDITY FANS**

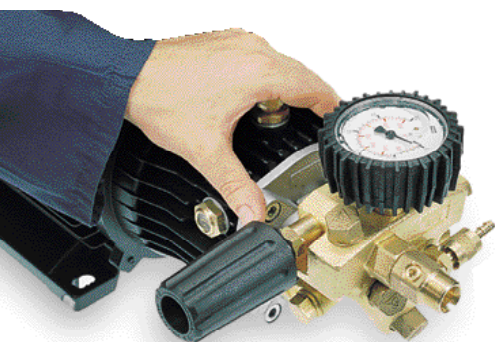

**PUMPS MADE IN HOUSE**

VIDEO



# ONE TECHNOLOGY MANY SOLUTIONS WHOEVER YOU ARE.

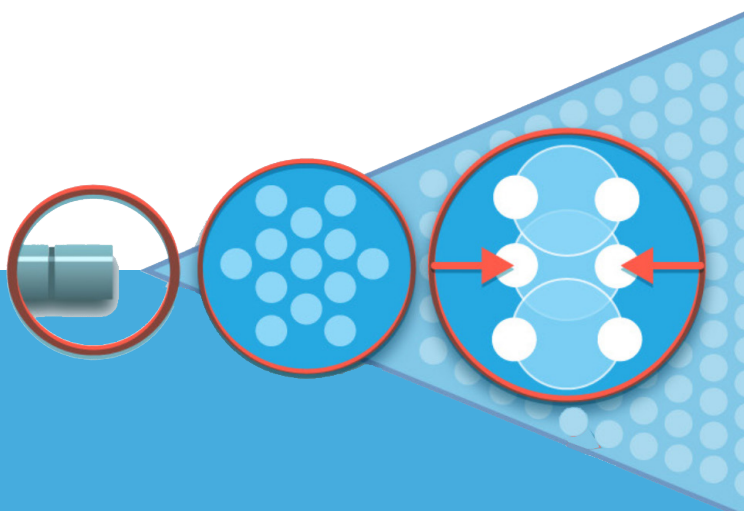

WATER IS FORCED AT HIGH PRESSURE THROUGH SPECIALIZED NOZZLES

NATURAL COOL PRODUCES MICRO-SIZED WATER DROPLETS WHICH ARE SIZED FOR EVAPORATION

AS MILLION OF DROPLETS EVAPORATE, SANITIZING THE ENVIROMENTS



# HUMIDITY CONTROL FOR FOODS

IT IS VERY IMPORTANT FOR A NUMBER OF FOOD PRODUCTS TO ENSURE QUALITY AND FRESHNESS WITH OPTIMUM HUMIDITY. ADDED AIR HUMIDIFICATION PROTECTS FROM WEIGHT REDUCTIONS DURING PRODUCTION AND STORAGE PROCESSES AND SUPPORTS THE RIPENING PROCESS IN MANY AREAS OF THE FOOD INDUSTRY.

WHEN FRUIT AND VEGETABLES ARRIVE IN THE KITCHEN, THEY HAVE USUALLY ALREADY TRAVELED A LONG WAY. SO THAT SUBSTANCES SUCH AS VITAMINS AND ENZYMES ARE PRESERVED, ADEQUATE CONDITIONS MUST BE MAINTAINED DURING TRANSPORT AND STORAGE.

VEGETABLES CAN ONLY BE STORED FOR TWO DAYS AT 20°C. AT A TEMPERATURE OF 2°C WITH 80% RELATIVE HUMIDITY, HOWEVER, THEY REMAIN AS FRESH AND RICH IN VITAMINS AS THEY WERE ON THE DAY THEY WERE BOUGHT, FOR UP TO TWO WEEKS.

AS FRUIT AND VEGETABLES DRY OUT AND SHRIVEL UP QUICKLY AT LOW TEMPERATURES, THE RIGHT HUMIDITY MUST BE ENSURED. AN APPROPRIATELY SIZED HUMIDIFICATION SYSTEM IN BOTH THE STOCKROOMS AND THE DISPLAY AREA ENSURES THAT FRUIT AND VEGETABLES REMAIN FRESH AND SALABLE, WITH NO LOSS OF WEIGHT.



- RAISING THE RELATIVE HUMIDITY INHIBITS MOISTURE LOSS.
- THE RIGHT HUMIDITY LEVEL ENSURES THAT PRODUCT QUALITY IS MAINTAINED.
- FRESH, JUST PICKED APPEARANCE INCREASES VALUE.
- LONGER STORAGE AND GREATER SHELF LIFE REDUCE WASTE
- DIRECT ROOM HUMIDIFICATION ENSURES THE RIGHT HUMIDITY LEVEL

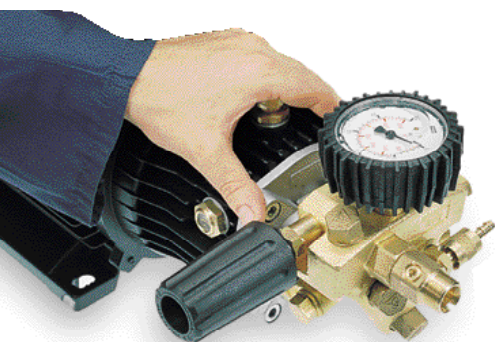
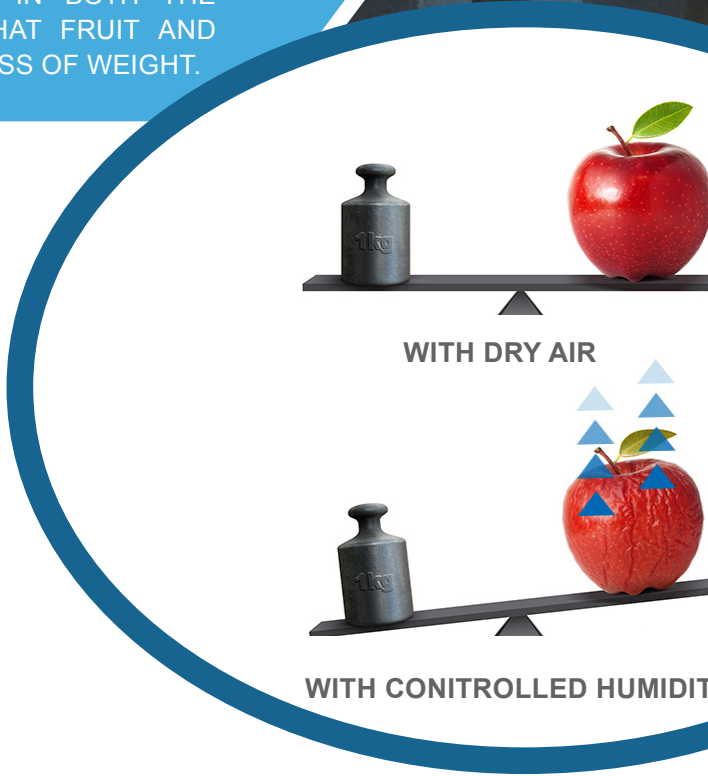

## PUMPS MADE IN HOUSE



VIDEO



# ONE TECHNOLOGY MANY SOLUTIONS WHOEVER YOU ARE.

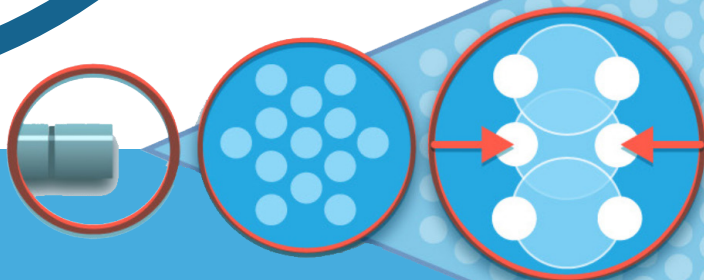

WATER IS FORCED AT HIGH PRESSURE THROUGH SPECIALIZED NOZZLES

NATURAL COOL PRODUCES MICRO-SIZED WATER DROPLETS WHICH ARE SIZED FOR EVAPORATION

AS MILLION OF DROPLETS EVAPORATE, SANITIZING THE ENVIROMENTS

# PRECOOLING

NATURAL COOL PRECOOLING SYSTEMS REDUCE CHILLER ELECTRICITY CONSUMPTION BY UP TO 37%, INCREASES THE COEFFICIENT OF COOLING PERFORMANCE BY UP CONDENSERS AND HEAT EXCHANGERS. THE NEW GENERATION OF PRE-COOLING SYSTEM SUITS ALL MODELS OF AIR-COOLED CHILLERS, DRY-COOLING CONDENSERS, HEAT EXCHANGERS, ROOFTOP UNITS AND REFRIGERATION UNITS.

NATURAL COOL COMBINES AN ADIABATIC EVAPORATIVE PRE-COOLING PROCESS AND CONDENSER PROTECTION WITH MECHANICAL AIR FILTRATION. THE INTELLIGENT NATURAL COOL ADIABATIC SYSTEM IS MOUNTED EXTERNALLY IN FRONT OF THE CONDENSERS OF THE COOLING EQUIPMENT.

- REDUCES CHILLER ELECTRICITY CONSUMPTION BY UP TO 37%
- INCREASES CHILLER COOLING CAPACITY BY UP TO 41%
- PROTECTS CHILLER CONDENSERS AND COMPRESSORS
- INCREASES THE SERVICE LIFE OF ALL CHILLERS
- MINIMAL WATER CONSUMPTION
- RETURN ON INVESTMENT FROM 5 TO 24 MONTHS

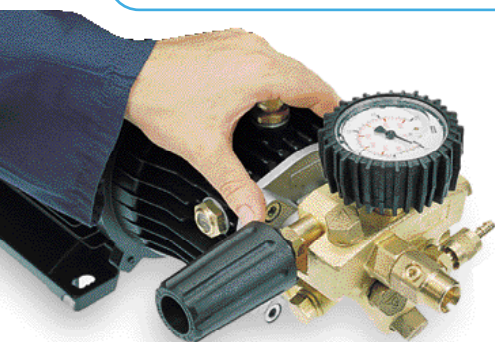

## PUMPS MADE IN HOUSE



VIDEO



# ONE TECHNOLOGY MANY SOLUTIONS WHOEVER YOU ARE.

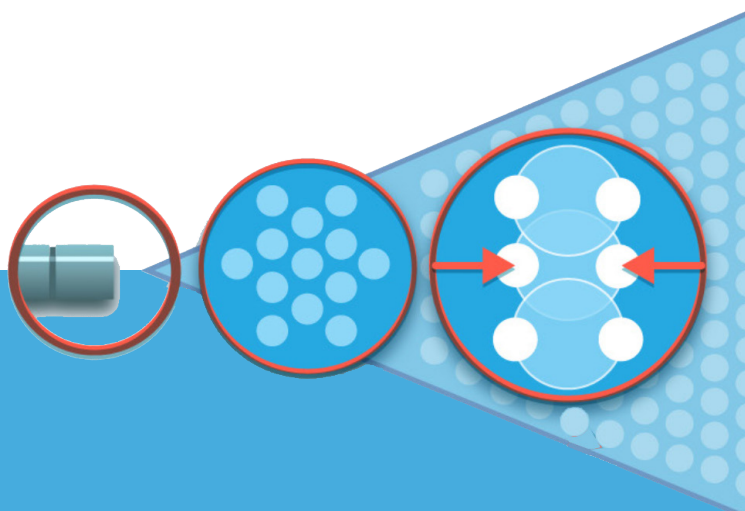

WATER IS FORCED AT HIGH PRESSURE THROUGH SPECIALIZED NOZZLES

NATURAL COOL PRODUCES MICRO-SIZED WATER DROPLETS WHICH ARE SIZED FOR EVAPORATION

AS MILLION OF DROPLETS EVAPORATE, SANITIZING THE ENVIROMENTS

# DUST SUPPRESSION

HIGH PRESSURE MISTING SYSTEMS ARE THE MOST APPROPRIATE SOLUTION FOR OUTDOOR AND INDOOR SMALL AND LARGE AREAS, TO SUPPRESS DUST GENERATED BY MATERIALS HANDLING OR MANUFACTURING PROCESSES IN GENERAL. NATURAL COOL MISTING SYSTEMS CREATE A HIGH CONCENTRATION OF ULTRA THIN WATER DROPLETS WITH AN AVERAGE DIAMETER OF 10 MICRONS (WITH THE POSSIBILITY TO ADD SURFACTANTS IN SOME CASES), HAVING THE ABILITY TO CAPTURE AND SUPPRESS PM10 AND SMALLER PARTICLES.

SURFACTANTS INSTANTLY BLANKET SUSPENDED DUST PARTICLES, INCREASING THEIR WEIGHT AND DRIVING THEM TO THE GROUND.

MISTING SYSTEM HELPS REMOVING EFFECTIVELY 0,1-1000 MICRON BREATHABLE DUST PARTICLES: DUST AGGLOMERATED IN THICK MIST HAS FEW WAY OF ESCAPE! THANKS TO THEIR MODULAR STRUCTURE, TECNOCOOLING SYSTEMS ALLOW A VERY EASY INSTALLATION, UNLIKE SOME OTHER DUST CONTROL TECHNOLOGIES THAT REQUIRE UPGRADING THE PRODUCTION SITES AND CONSEQUENTLY RESULTING EXPENSIVE IN COSTS AND POORLY FLEXIBLE ON THE WHOLE.



- **NATURAL COOL SYSTEMS IS CUSTOMIZED AND MODULAR.**
- **MOUNTING IS EASY AND DOES NOT REQUIRE NEITHER SPECIAL PLANNER PROJECTS NOR PERMITS.**
- **PROTECTS CHILLER CONDENSERS AND COMPRESSORS**
- **THE WORKING IS COMPLETELY AUTOMATIC AND DOES NOT NEED ANY SPECIAL ATTENTION.**

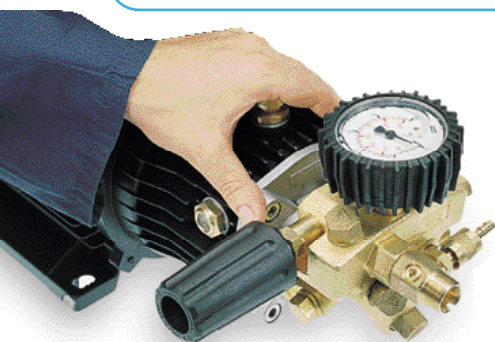

## PUMPS MADE IN HOUSE



# ONE TECHNOLOGY MANY SOLUTIONS WHOEVER YOU ARE.

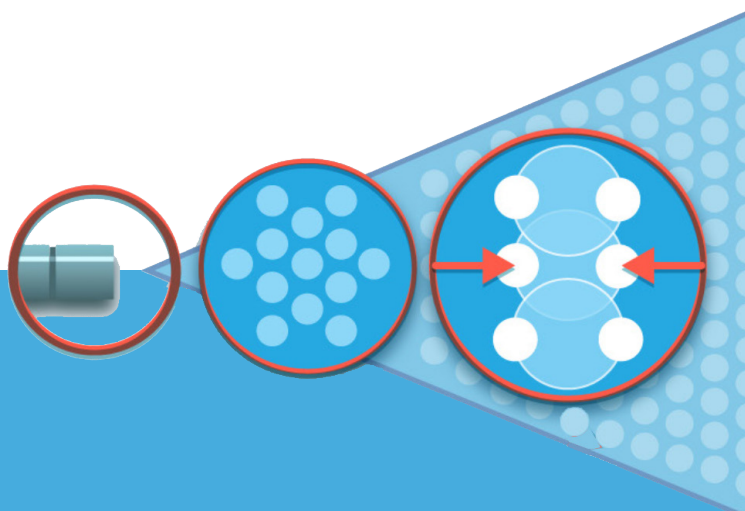

WATER IS FORCED AT HIGH PRESSURE THROUGH SPECIALIZED NOZZLES

NATURAL COOL PRODUCES MICRO-SIZED WATER DROPLETS WHICH ARE SIZED FOR EVAPORATION

AS MILLION OF DROPLETS EVAPORATE, SANITIZING THE ENVIROMENTS



# SPRAY SERIES

E342

Spray is the most compact and versatile solution to cool, create fog effects, humidify, suppress dust and odours in small and medium sized areas. Wide variety of accessories and types of lines configurable as required. The best compromised between price/quality.

10 YEARS  
GUARANTEE



24H



105 Bar



<50dB

5 MICRON FILTER

PAINTED STEEL HANDLE FOR EASY TRANSPORTATION

DIGITAL CYCLING TIMER

HIGH PRESSURE RELEASE SOLENOID VALVE



DRAIN  
BUILT-IN SYSTEM  
NOT NEED  
EXTERNAL  
DISCHARGE

Patented SIMMM pump  
AXA model with no  
overheating system

BACK CONNECTOR FOR FANS



AXA SIMMM PUMP  
900 RPM MOTOR < 50 dB  
OPTIMIZED FOR INDUSTRIAL  
INSTALLATIONS

FLOW RATE VALVE (PRESSURE REGULATOR)



INLINE SOLENOID VALVE



VIDEO

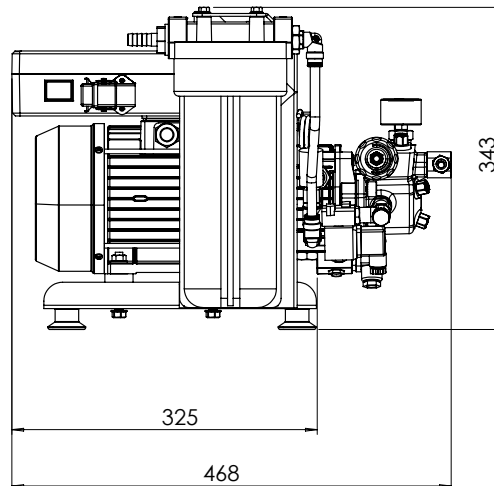
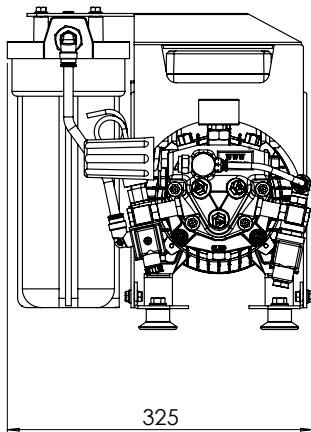

CE

MADE  
IN ITALY

10 YEARS GUARANTEE - 10 YEAR GUARANTEE

## TECHNICAL DATA

- SIMMM pump AXA model with no overheating system (CE approved)
- Patented flow rate valve (large range of nozzle numbers with the same model)
- Max working pressure up to 105 bar
- Professional gauge
- Water seals in viton
- Coated ceramic piston
- SS valves
- Safety water pressure switch (water loss)
- In line low pressure solenoid valve
- High pressure release solenoid valve
- "H" class motor with 900 rpm
- Thermal protection
- Lowest noise level 50 dB
- Painted steel frame
- Electric plug as standard
- External misting fan socket (230 volt-10 A)



MODEL	E342
PRESSIONE (BAR)	70-105
NOZZLES NUMBER (0.2 MM)	70
PUMP	SIMMM AXA
MIN FLOW RATE (LT/MIN)	1
MAX FLOW RATE (LT/MIN)	5
MOTOR SPEED (RPM)	900
VOLTAGE (VOLT)	230/115 50/60Hz.*
POWER (KW/H)	0.92
MAX DAILY USE (HOURS)	24
WEIGHT (KG)	28
DIMENSIONS LXHXXP (CM)	47x32x34

\* ON REQUEST





# SPRAY ADVANCE SERIES

E346

Spray advance is the most compact and versatile solution to cool, create fog effects, humidify, suppress dust and odours in small and medium sized areas. Wide variety of accessories and types of lines configurable on request. The new control panel called Lucky3 enables rapid and precise settings of work times and management of any optional sensors connected.

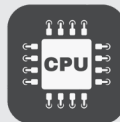
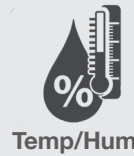

COOL APP  
SMARTPHONE MANAGEMENT



5 MICRON FILTER

PAINTED STEEL HANDLE  
FOR EASY  
TRANSPORTATION

HIGH PRESSURE RELEASE  
SOLENOID VALVE



DRAIN  
BUILT-IN SYSTEM  
NOT NEED  
EXTERNAL  
DISCHARGE



Patented SIMMM pump  
AXA model with no  
overheating system

BACK CONNECTOR  
FOR FANS AND REMOTE CONTACT

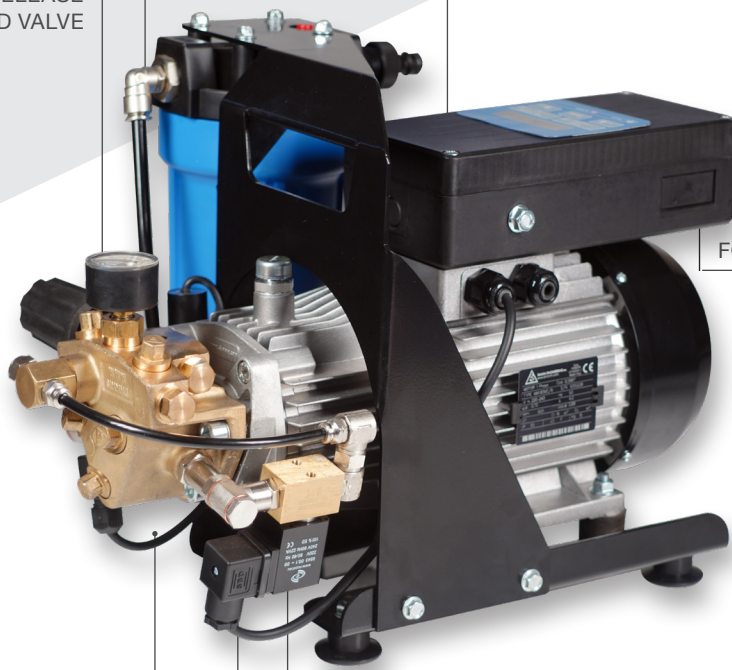

AXA SIMMM PUMP  
900 RPM MOTOR < 50 dB  
OPTIMIZED FOR INDUSTRIAL  
INSTALLATIONS

FLOW RATE VALVE  
(PRESSURE REGULATOR)



INLINE SOLENOID VALVE  
SAFETY DIGITAL PRESSURE  
READER



RADIO REMOTE CONTROL  
ON/OFF PUMP AND FAN



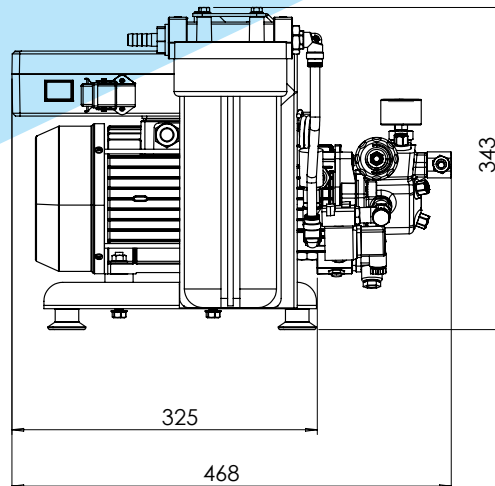
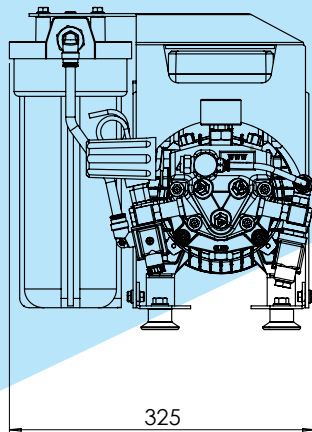

## TECHNICAL DATA

- SIMMM pump AXA model with no overheating system (CE approved)
- Patented flow rate valve (large range of nozzle numbers with the same model)
- Max working pressure up to 105 bar
- Professional gauge
- Water seals in viton
- Coated ceramic piston
- SS valves
- Safety water pressure switch (water loss)
- In line low pressure solenoid valve
- High pressure release solenoid valve
- "H" class motor with 900 rpm
- Thermal protection
- Lowest noise level 50 dB
- Low voltage control panel (12 volt)
- Radio remote control
- Digital cycling timer
- Pump and fan life time counter
- Pump overheating warning alarm
- Connection for remote control
- Modbus RS485 (BMS) connection
- Management by smartphone (available soon)
- External misting fan socket (230 volt-10 A)
- Painted steel frame
- Graphic alarm warning on display
- No water alarm
- Maintenance alarm
- Electric plug as standard
- 5 micron filter as standard

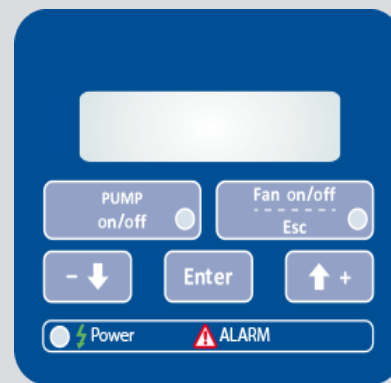

CYLING TIMER

REMOTE CONTROL

LIFE TIME PUMP/FAN

WEEKLY PROGRAM

OPERATING ALARMS

SMARTPHONE CONTROL

BMS - MODBUS RS485

MODEL	E346
PRESSIONE (BAR)	70-105
NOZZLES NUMBER (0.2 MM)	70
PUMP	SIMMM AXA
MIN FLOW RATE (LT/MIN)	1
MAX FLOW RATE (LT/MIN)	5
MOTOR SPEED (RPM)	900
VOLTAGE (VOLT)	230/115 50/60Hz.*
POWER (KW/H)	0.92
MAX DAILY USE (HOURS)	24
WEIGHT (KG)	28
DIMENSIONS LXHPX (CM)	47x32x34

\* ON REQUEST



# PROFY ADVANCE SERIES

E348

The Profy Advance was developed to address the demands of medium and large-scale applications. It is furnished with a remote control and features illustrated electronics for overseeing the mist flow. Designed for use in private companies or businesses where automatic temperature control is unnecessary, the Profy Advance boasts a unique AXA This enables silent operation, with the capability for minimum and adjustable flows as needed.

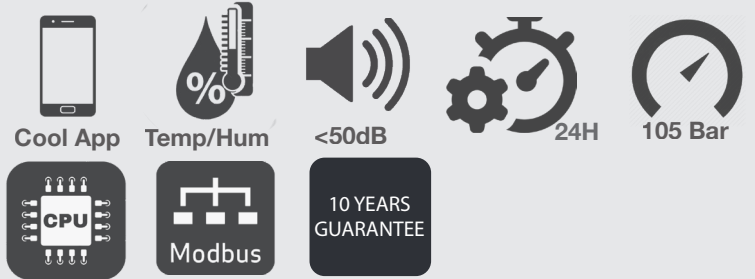

COOL APP  
SMARTPHONE MANAGEMENT



PAINTED STEEL HANDLE  
FOR EASY TRANSPORTATION

FLOW RATE VALVE  
(PRESSURE REGULATOR)

HIGH PRESSURE  
RELEASE SOLENOID  
VALVE

DRAIN  
BUILT-IN SYSTEM  
NOT NEED  
EXTERNAL  
DISCHARGE



BACK CONNECTOR  
FOR FANS



AXA SIMMM PUMP  
900 RPM MOTOR < 50 dB  
OPTIMIZED FOR INDUSTRIAL  
INSTALLATIONS



5 MICRON DETACHABLE FILTER  
WITH WALL SUPPORT (OPTIONAL)



INLINE SOLENOID VALVE

SAFETY DIGITAL  
PRESSURE READER



RADIO REMOTE CONTROL  
ON/OFF PUMP AND FAN

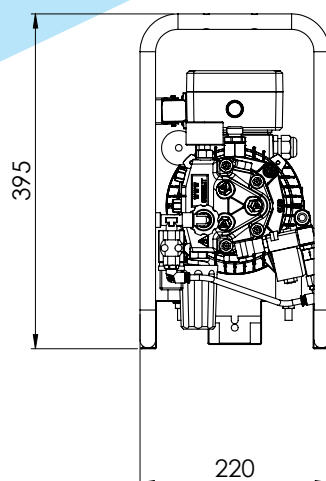
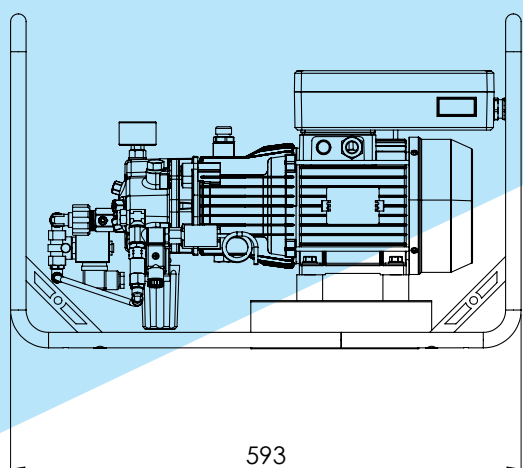

## TECHNICAL DATA

- SIMMM pump AXA model with no overheating system (CE approved)
- Patented flow rate valve (large range of nozzle numbers with the same model)
- Max working pressure up to 105 bar
- Professional gauge
- Water seals in viton
- Coated ceramic piston
- SS valves
- Safety water pressure switch (water loss)
- In line low pressure solenoid valve
- High pressure release solenoid valve
- "H" class motor with 900 rpm
- Thermal protection
- Lowest noise level 50 dB
- Low voltage control panel (12 volt)
- Radio remote control
- Digital cycling timer
- Pump and fan life time counter
- Pump overheating warning alarm
- Connection for remote control
- Modbus RS485 (BMS) connection
- Management by smartphone (available soon)
- External misting fan socket (230 volt-10 A)
- Painted steel frame
- Graphic alarm warning on display
- No water alarm
- Maintenance alarm
- Electric plug as standard
- 5 micron filter as standard



CYLING TIMER

REMOTE CONTROL

LIFE TIME PUMP/FAN

WEEKLY PROGRAM

OPERATING ALARMS

SMARTPHONE CONTROL

BMS - MODBUS RS485

MODEL	E348
PRESSIONE (BAR)	70-105
NOZZLES NUMBER (0.2 MM)	70
PUMP	SIMMM AXA
MIN FLOW RATE (LT/MIN)	1
MAX FLOW RATE (LT/MIN)	5
MOTOR SPEED (RPM)	900
VOLTAGE (VOLT)	230/115 50/60Hz.*
POWER (KW/H)	0.92
MAX DAILY USE (HOURS)	24
WEIGHT (KG)	28
DIMENSIONS LXXXP (CM)	60x22x40



# MISTY ADVANCE SERIES

E347

The Misty Advance was created to respond to medium and large scale needs. It comes equipped with remote control and illustrated electronics for the management of mist flow. Misty Advance has been designed for spaces private companies or businesses that do not require automatic temperature control.

The special patented AXA axial type pump allows for silent operation, with minimum and variable flows when required.

- Cool App
- Temp/Hum
- <50dB
- 24H
- 105 Bar
- CPU
- Modbus
- 10 YEARS GUARANTEE

COOL APP  
SMARTPHONE MANAGEMENT



PAINTED CABINET  
WIT NO CORROSION  
TREATMENT.

HIGH PRESSURE RELEASE  
SOLENOID VALVE



NEW  
DRAIN  
BUILT-IN SYSTEM  
NOT NEED  
EXTERNAL  
DISCHARGE



5 MICRON DETACHABLE FILTER  
MOUNTED ON PUMP (OPTIONAL)



INSIDE COOLING FAN

Patented SIMMM pump  
AXA model with no  
overheating system

BACK CONNECTOR  
FOR FANS



HUMIDISTAT - THERMOSTAT  
BUILT-IN (OPTIONAL)



AXA SIMMM PUMP  
900 RPM MOTOR < 50 dB  
OPTIMIZED FOR INDUSTRIAL  
INSTALLATIONS



INLINE SOLENOID VALVE

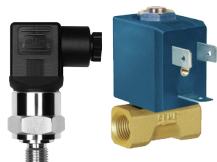

SAFETY DIGITAL



RADIO REMOTE CONTROL  
ON/OFF PUMP AND FAN

VIDEO





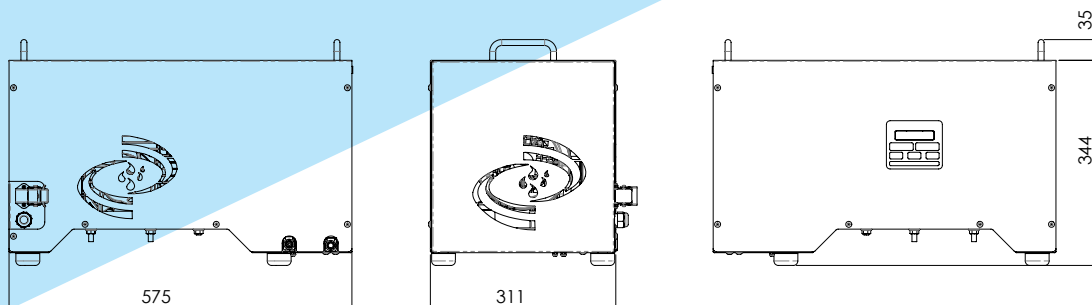

CE

MADE  
IN ITALY

10 YEARS GUARANTEE - 10 YEAR GUARANTEE

## TECHNICAL DATA

- SIMMM pump AXA model with no overheating system (CE approved)
- Patented flow rate valve (large range of nozzle numbers with the same model)
- Max working pressure up to 105 bar
- Professional gauge
- Water seals in viton
- Coated ceramic piston
- SS valves
- Safety water pressure switch (water loss)
- In line low pressure solenoid valve
- High pressure release solenoid valve
- "H" class motor with 900 rpm
- Thermal protection
- Lowest noise level 50 dB
- Low voltage control panel (12 volt)
- Radio remote control
- Digital cycling timer
- Pump and fan life time counter
- Pump overheating warning alarm
- Connection for remote control
- Modbus RS485 (BMS) connection
- Humidistat and thermostat (optional)
- Management by smartphone (available soon)
- Auto programs
- External misting fan socket (230 volt-10 A)
- Painted steel cabinet
- Graphic alarm warning on display
- No water alarm
- Maintenance alarm
- Electric plug as standard
- 5 micron filter (optional)

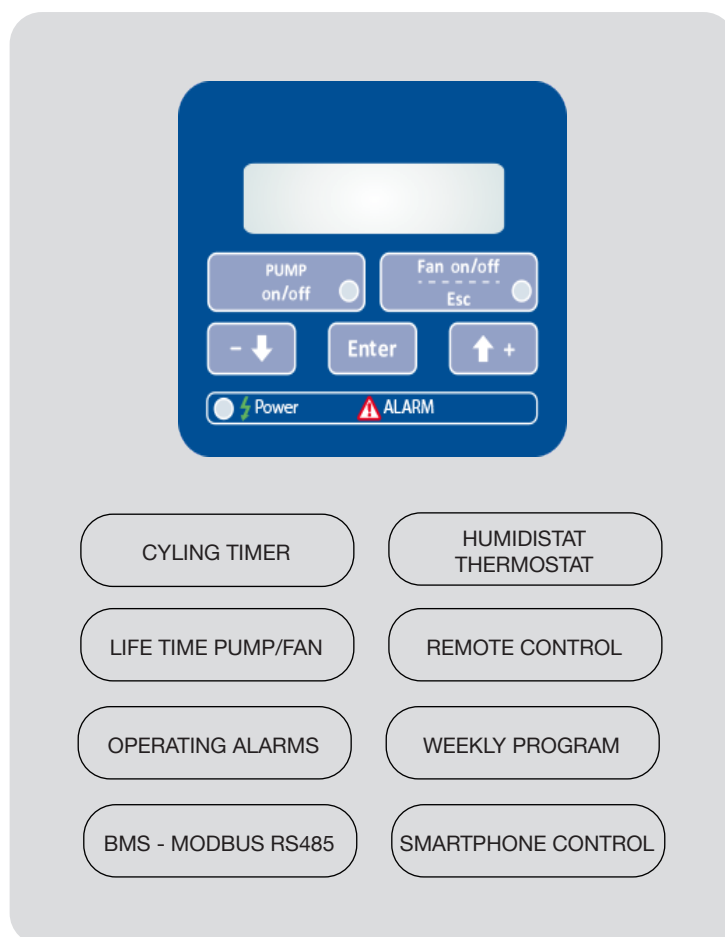

MODEL	E347
PRESSIONE (BAR)	70-105
NOZZLES NUMBER (0.2 MM)	70
PUMP	SIMMM AXA
MIN FLOW RATE (LT/MIN)	1
MAX FLOW RATE (LT/MIN)	5
MOTOR SPEED (RPM)	900
VOLTAGE (VOLT)	230/115 50/60Hz.*
POWER (KW/H)	0.92
MAX DAILY USE (HOURS)	24
WEIGHT (KG)	28
DIMENSIONS LXHXP (CM)	57x31x35



# FOGGY ADVANCE SERIES

E365

The Foggy Advance was created to respond to small and medium scale needs and comes equipped with remote control and illustrated electronics for the management of mist flow. They have been designed for small spaces private companies or businesses that do not require automatic temperature control. The special patented AXA axial type pump allows for silent operation, with minimum and variable flows when required. Thanks to the digital management of the working times it is possible to adjust atomisation to the different conditions of the day.

- Cool App
- Temp/Hum
- <50dB
- 24H
- 105 Bar
- CPU
- Modbus
- 10 YEARS GUARANTEE

COOL APP  
SMARTPHONE MANAGEMENT



PAINTED CABINET  
WIT NO CORROSION  
TREATMENT.

Patented SIMMM pump  
AXA model with no  
overheating system

HIGH PRESSURE RELEASE  
SOLENOID VALVE



BACK CONNECTOR  
FOR FANS



NEW  
DRAIN  
BUILT-IN SYSTEM  
NOT NEED  
EXTERNAL  
DISCHARGE

HUMIDISTAT - THERMOSTAT  
BUILT-IN (OPTIONAL)



AXA SIMMM PUMP  
900 RPM MOTOR < 50 dB  
OPTIMIZED FOR INDUSTRIAL  
INSTALLATIONS

5 MICRON DETACHABLE FILTER  
MOUNTED ON PUMP (OPTIONAL)

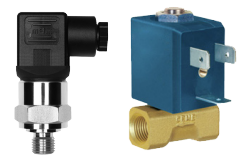

INLINE SOLENOID VALVE  
SAFETY DIGITAL  
PRESSURE READER



RADIO REMOTE CONTROL  
ON/OFF PUMP AND FAN



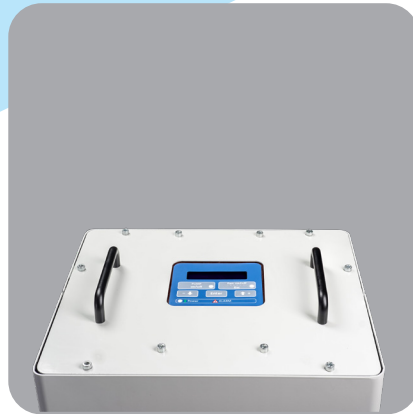

## TECHNICAL DATA

- SIMMM pump AXA model with no overheating system (CE approved)
- Patented flow rate valve (large range of nozzle numbers with the same model)
- Max working pressure up to 105 bar
- Professional gauge
- Water seals in viton
- Coated ceramic piston
- SS valves
- Safety water pressure switch (water loss)
- In line low pressure solenoid valve
- High pressure release solenoid valve
- "H" class motor with 900 rpm
- Thermal protection
- Lowest noise level 50 dB
- Low voltage control panel (12 volt)
- Radio remote control
- Digital cycling timer
- Pump and fan life time counter
- Pump overheating warning alarm
- Connection for remote control
- Modbus RS485 (BMS) connection
- Humidistat and thermostat (optional)
- External misting fan socket (230 volt-10 A)
- Painted steel cabinet
- Graphic alarm warning on display
- No water alarm
- Maintenance alarm
- Electric plug as standard
- 5 micron filter (optional)

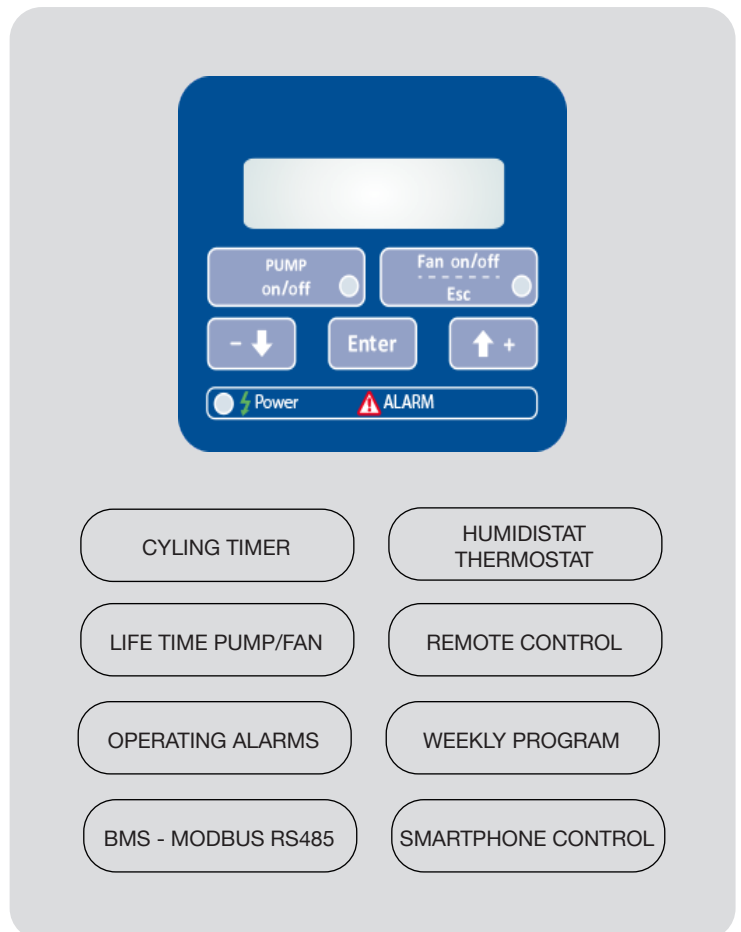

MODEL	E365
PRESSIONE (BAR)	70-105
NOZZLES NUMBER (0.2 MM)	70
PUMP	SIMMM AXA
MIN FLOW RATE (LT/MIN)	1
MAX FLOW RATE (LT/MIN)	5
MOTOR SPEED (RPM)	900
VOLTAGE (VOLT)	230/115 50/60Hz.*
POWER (KW/H)	0.92
MAX DAILY USE (HOURS)	24
WEIGHT (KG)	28
DIMENSIONS LXHXXP (CM)	57x31x35





# HPro SERIES

E304 | E298 | E299 | E300



Designed for industrial or business environments the HPro Misting module provides for precise solutions for instalation of medium and large dimension, The patented mechanics with axial cam combined with a high efficiency pumping unit is supported by

electronic management (Eddy5 control panel) by means of a further enhanced Soft Touch electronic board. The unit is contained in a AISI 304 stainless steel chassis equipped with a cooling fan.



Web interface



Multi probe



<50dB



Water loss alarm



24H

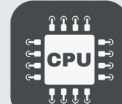

105 Bar



Modbus

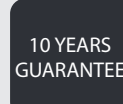

10 YEARS GUARANTEE



EDDY 5 CONTROL PANEL

REMOTE PANELS OVER IP (OPTIONAL)

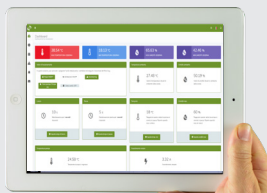

WEB INTERFACE CONTROL BY TABLET PC AND SMARTPHONE

RJ45 ETHERNET PLUG



DIG. PRESSURE READER

HIGH PRESSURE RELEASE SOLENOID VALVE



NEW DRAIN BUILT-IN SYSTEM NOT NEED EXTERNAL DISCHARGE



DIG. FLOW RATE METER

INSIDE COOLING FAN

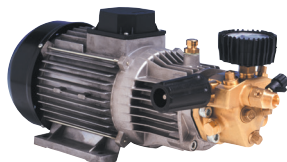

AXA SIMMM PUMP 900 RPM MOTOR < 50 dB

RO SYSTEM AND REMOTE ON/OFF CONTROL

SOCKETMODBUS RS485 DIGITAL INTERFACE



RADIO REMOTE CONTROL ON/OFF PUMP AND FAN

FANS SOCHET (230/115 VOLT - 10 AMPS)



HUMIDITY/TEMPERATURE PROBE MAX 4 WITH MULTI READING (OPTIONAL)



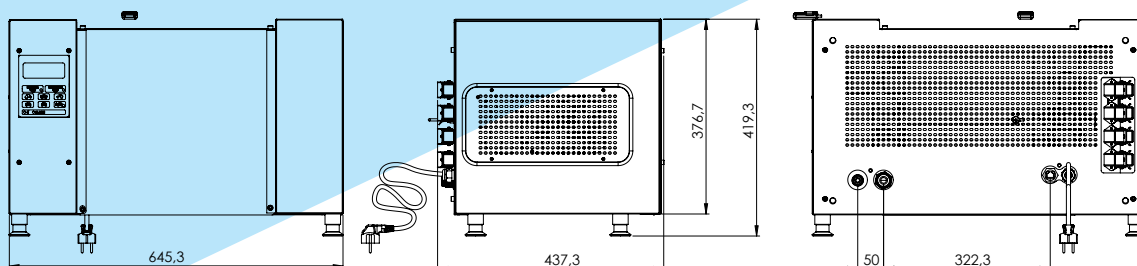

## TECHNICAL DATA

- SIMMM pump AXA model with no overheating system (CE approved) Patented flow rate valve (large range of nozzle numbers with the same model)
- Max working pressure up to 105 Bar
- Professional gauge
- Water seals in viton
- Safety water pressure switch
- High pressure release solenoid valve
- "H" class motor with low speed (900 rpm)
- Lowest noise level 50 dB
- Low voltage control panel (12 volt)
- Radio remote control
- Digital cycling timer
- Digital water litre counter
- Digital pressure liter reader
- Temperature and humidity program
- Weekly timer
- Control via LAN, by any smartphone, tablet, PC or Mac
- Digital alarms with display warning message by Email
- Washing line high pressure solenoid valve
- Automatic fan On/Off switch (230 volt plug built-in)
- Auto program "A" adjusting the cooling power based on temperature
- Auto program "B" adjusting the cooling power based on humidity
- Auto program "C" humidity management from
- Auto program "D" humidity management with AHU control
- Self-diagnosis
- Soft touch panel
- Notification program (with alert by email)
- Anti-Legionella Pneumophila automatic system equipped with certified products
- Built-in cooling fan
- Reverse Osmosi connection socket
- Remote on/off control
- Multiply control panels over IP ethernet connections
- Datalogger of all the pump parameters
- Firmware update
- Remote on/off control
- Alarms database record (last 10 alarms)
- Digital alarms with display warning message sent by SMS or by Email:
  - Water Loss
  - High pressure water leaking
  - Pump overheating
  - Motor overload
  - Maintenance time notification (oil change, seals check etc..)
  - Low/max flow rate
  - Low temperature in the pipes (Ice)
- Modbus rs 485 (bms) communication protocols
- Simultaneous Temp/hum probes connection (max 4) for a better humidification
- In line 0-10 input for UTA control
- Out connection for siren or light in case of alarm
- 4 different automatic programs for cooling and humidity control

MODEL	E304	E298	E299	E300
PRESSIONE (BAR)	70-105	70-105	70/105	70/105
NOZZLES NUMBER (0.2 MM)	40	70	100	210
PUMP	SIMMM AXA	SIMMM AXA	SIMMM AXA	SIMMM AXA
MIN FLOW RATE (LT/MIN)	0.5	2.5	3.9	7.8
MAX FLOW RATE (LT/MIN)	3.5	6	7.8	18
MOTOR SPEED (RPM)	900	900	900	1.450
VOLTAGE (VOLT)	230/115 50/60 Hz.*	230/115 50/60 Hz.*	230/115 50/60Hz.*	230/115 50/60Hz.*
POWER (KW/H)	0.92	0.92	2.60	2.90
MAX DAILY USE (HOURS)	24	24	24	24
WEIGHT (KG)	36	36	36	36
DIMENSIONS LXHXP (CM)	65x44x42	65x44x42	65x44x42	65x44x42

\* ON REQUEST



# HPro VFD SERIES

E305 | E306 | E307

Designed for industrial or business environments the HPro Misting module provides for precise solutions for installation of medium and large dimension, The patented mechanics with axial cam combined with a high efficiency pumping unit is supported by

electronic management (Eddy5 control panel) by means of a further enhanced Soft Touch electronic board. The unit is contained in a AISI 304 stainless steel chassis equipped with a cooling fan. VFD built-in for automatic speed control

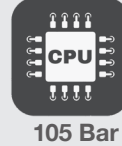

EDDY 5 CONTROL PANEL

REMOTE PANELS OVER IP (OPTIONAL)

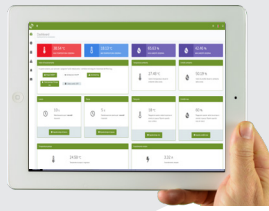

WEB INTERFACE CONTROL BY TABLET PC AND SMARTPHONE

RJ45 ETHERNET PLUG



DIG. PRESSURE READER

HIGH PRESSURE RELEASE SOLENOID VALVE



NEW DRAIN BUILT-IN SYSTEM NOT NEED EXTERNAL DISCHARGE



DIG. FLOW RATE MEETER

INSIDE COOLING FAN



AXA SIMMM PUMP 900 RPM MOTOR < 50 dB

RO SYSTEM AND REMOTE ON/OFF CONTROL

SOCKETMODBUS RS485 DIGITAL INTERFACE



RADIO REMOTE CONTROL ON/OFF PUMP AND FAN

FANS SOCHET (230/115 VOLT - 10 AMPS)



HUMIDITY/TEMPERATURE PROBE MAX 4 WITH MULTI READING (OPTIONAL)





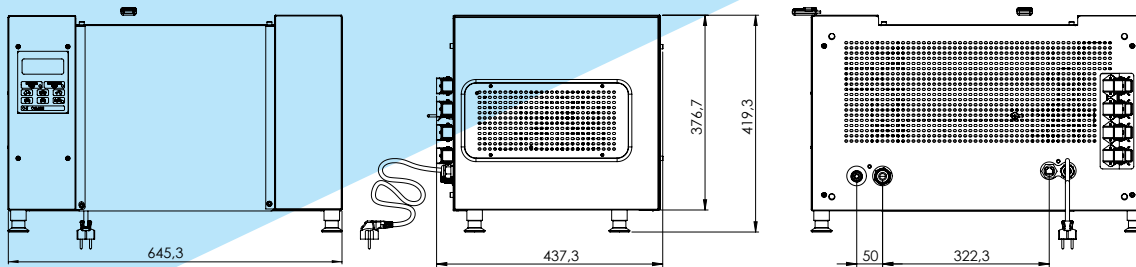

## TECHNICAL DATA

- SIMMM pump AXA model with no overheating system (CE approved) Patented flow rate valve (large range of nozzle numbers with the same model)
- Max working pressure up to 105 Bar
- Professional gauge
- Water seals in viton
- Safety water pressure switch
- High pressure release solenoid valve
- "H" class motor with low speed (900 rpm)
- Lowest noise level 50 dB
- Low voltage control panel (12 volt)
- Radio remote control
- Digital cycling timer
- Digital water litre counter
- Digital pressure liter reader
- Temperature and humidity program
- Weekly timer
- Control via LAN, by any smartphone, tablet, PC or Mac
- Digital alarms with display warning message by Email
- Washing line high pressure solenoid valve
- Automatic fan On/Off switch (230 volt plug built-in)
- Auto program "A" adjusting the cooling power based on temperature
- Auto program "B" adjusting the cooling power based on humidity
- Auto program "C" humidity management from
- Auto program "D" humidity management with AHU control
- Self-diagnosis
- Soft touch panel
- Soft start to reduce start-up current
- Anti-Legionella Pneumophila automatic system equipped with certified products
- Built-in cooling fan
- Reverse Osmosi connection socket
- Remote on/off control
- Multiply control panels over IP ethernet connections
- Datalogger of all the pump parameters
- Firmware update
- Remote on/off control
- Alarms database record (last 10 alarms)
- Digital alarms with display warning message sent by SMS or by Email:
  - Water Loss
  - High pressure water leaking
  - Pump overheating
  - Motor overload
  - Maintenance time notification (oil change, seals check etc.)
  - Low/max flow rate
  - Low temperature in the pipes (Ice)
- Modbus rs 485 (bms) comunciation protocols
- Simultaneous Temp/hum probes connection (max 4) for a better humidification
- In line 0-10 input for UTA control
- Out connection for siren or light in case of alarm
- 4 different automatic programs for cooling and humidity control

MODEL	E305	E306	E307
PRESSIONE (BAR)	70-105	70-105	70-105
NOZZLES NUMBER (0.2 MM)	60	150	250
PUMP	SIMMM AXA	SIMMM AXA	SIMMM AXA
MIN FLOW RATE (LT/MIN)	1.2	1.90	5.70
MAX FLOW RATE (LT/MIN)	4.68	9.8	20
MOTOR SPEED (RPM)	1.450	1.450	1.450
VOLTAGE (VOLT)	230/115 50/60 Hz.*	230/115 50/60 Hz.*	230/115 50/60 Hz.*
POWER (KW/H)	0.92	0.92	2.90
MAX DAILY USE (HOURS)	24	24	24
WEIGHT (KG)	36	36	36
DIMENSIONS LXHX (CM)	65x44x42	65x44x42	65x44x42

\* ON REQUEST



# HPro Mz SERIES

E302 | E303 | E308

Designed for industrial or business environments the HPro Misting module provides for precise solutions for installation of medium and large dimension. The patented mechanics with axial cam combined with a high efficiency pumping unit is supported by

electronic management by means of a further enhanced Soft Touch electronic board. (EDDY5 control panel)  
The unit is contained in a AISI 304 stainless steel chassis equipped with a cooling fan.



-   
Web interface
-   
Multi probe
-   
<50dB
-   
Water loss alarm
- 
-   
24H
-   
105 Bar
-   
Modbus
-   
10 YEARS GUARANTEE



EDDY 5 CONTROL PANEL

REMOTE PANELS OVER IP (OPTIONAL)

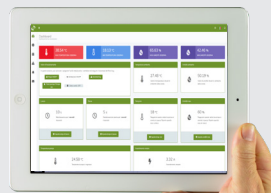

WEB INTERFACE CONTROL BY TABLET PC AND SMARTPHONE

RJ45 ETHERNET PLUG



DIG. PRESSURE READER

HIGH PRESSURE RELEASE SOLENOID VALVE



NEW DRAIN BUILT-IN SYSTEM NOT NEED EXTERNAL DISCHARGE

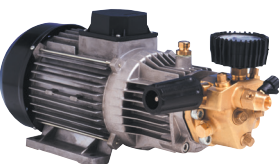

AXA SIMMM PUMP 900 RPM MOTOR < 50 dB



DIG. FLOW RATE MEETER

INSIDE COOLING FAN



RO SYSTEM AND REMOTE ON/OFF CONTROL

SOCKETMODBUS RS485 DIGITAL INTERFACE



RADIO REMOTE CONTROL ON/OFF PUMP AND FAN

FANS SOCHET (230/115 VOLT - 10 AMPS)



HUMIDITY/TEMPERATURE PROBE MAX 4 WITH MULTI READING (OPTIONAL)



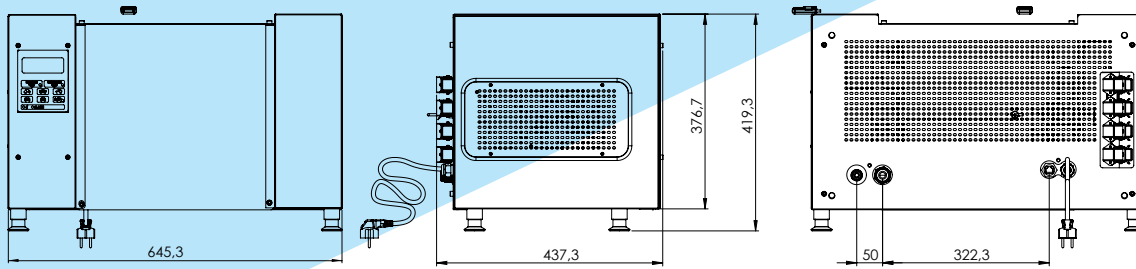

**TECHNICAL DATA**

- SIMMM pump AXA model with no overheating system (CE approved)
- Patented flow rate valve (large range of nozzle numbers with the same model)
- Max working pressure up to 105 Bar
- Professional gauge
- Safety water pressure switch
- High pressure release solenoid valve
- “H” class motor with low speed (900 rpm)
- Thermal protection
- Lowest noise level 50 dB
- Low voltage control panel (12 volt)
- Radio remote control
- Digital cycling timer
- Digital water litre counter
- Digital pressure reader
- Temperature and humidity program
- AISI 304 stainless steel cabinet
- Built-in cooling fan
- Anti-Legionella Pneumophila automatic system equipped with certified products
- Reverse Osmosi connection socket
- Remote on/off control
- Multiply control panels over IP ethernet connections
- Datalogger of all the pump parameters
- Firmware update
- Remote on/off control
- Modbus RS485 digital interface
- Weekly timer
- Control via LAN, by any smartphone, tablet, PC or Mac
- Digital alarms on display warning message sent or by Email
- Washing line high pressure solenoid valve
- Automatic fan On/Off switch (230 volt plug built-in)
- Auto program
- Self-diagnosis
- Digital alarms with display warning message
- Soft touch panel
- High efficiency VFD

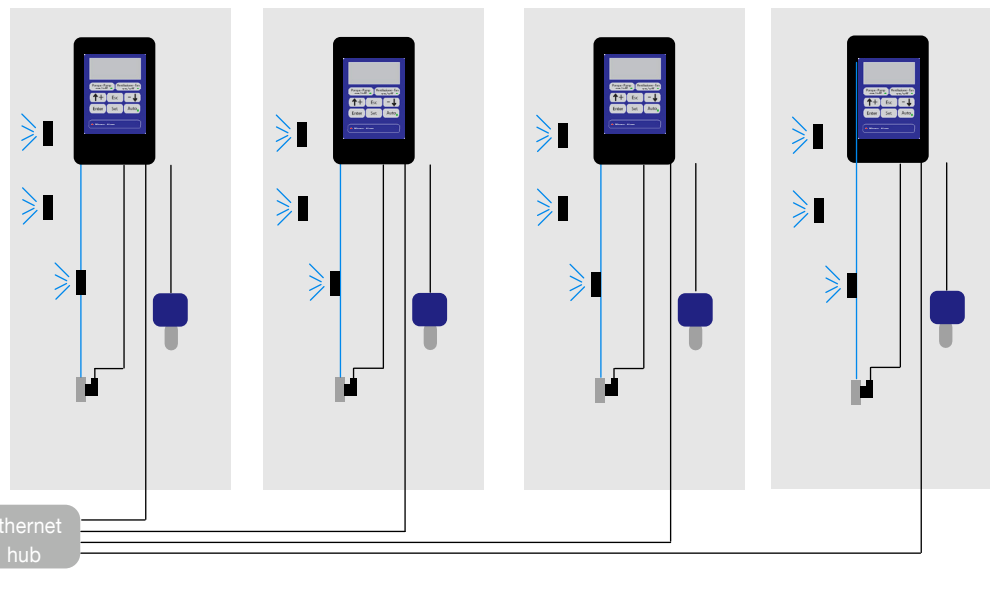

MODEL	E305	E306	E307
PRESSIONE (BAR)	70-105	70-105	70-105
NOZZLES NUMBER (0.2 MM)	60	150	250
PUMP	SIMMM AXA	SIMMM AXA	SIMMM AXA
MIN FLOW RATE (LT/MIN)	1.2	1.90	5.70
MAX FLOW RATE (LT/MIN)	4.68	9.8	20
MOTOR SPEED (RPM)	1.450	1.450	1.450
VOLTAGE (VOLT)	230/115 50/60 Hz.*	230/115 50/60 Hz.*	230/115 50/60 Hz.*
POWER (KW/H)	0.92	0.92	2.90
MAX DAILY USE (HOURS)	24	24	24
WEIGHT (KG)	36	36	36
DIMENSIONS LXHXPC (CM)	65x44x42	65x44x42	65x44x42

\* ON REQUEST



# AXA SERIES

AXA2.20 | AXA5.40 | AXA10.80 | AXA50.100 | AXA.100.350

Tailored for industrial and business settings, the AXA series misting pump delivers precise solutions for medium and large-scale environments. The patented mechanics featuring an Axial model, coupled with a high-efficiency pumping unit, is complemented by a flow rate valve.(By-Pass)

This product is designed specifically for professional users who demand reliability, efficiency, and uninterrupted operation for a duration of up to 16 hours per day.

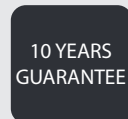

PROFESSIONAL PRESSURE GAUGE

HIGH PERFORMANCE ELECTRIC MOTOR

- "H" CALSS
- LOW SPEED 900 RPM < 50 DB
- IP54
- INTEGRATED VENTILATION

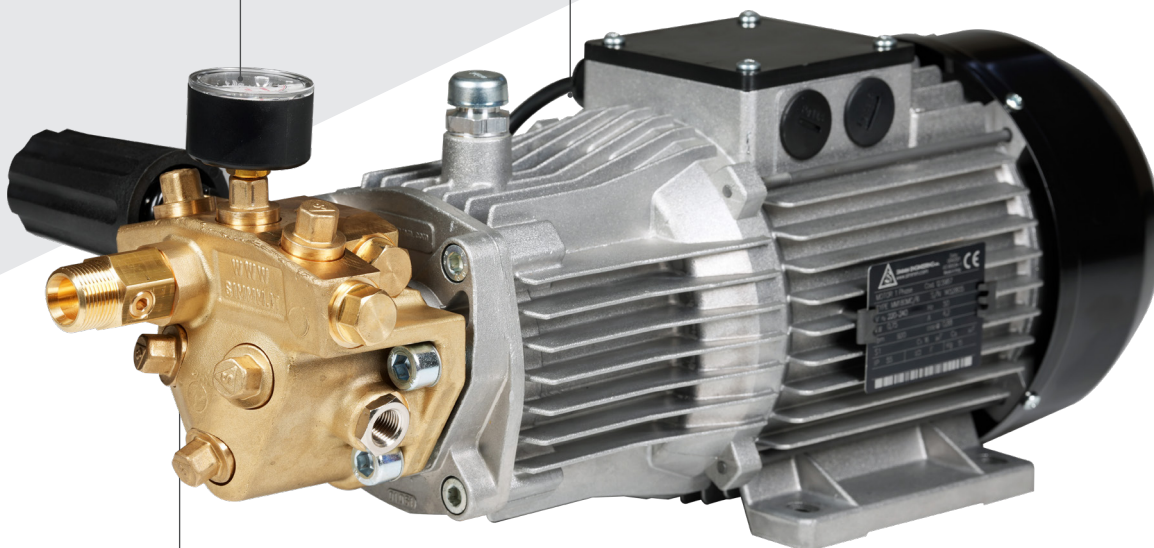

PATENTED SIMMM AXIAL PUMP

- BRASS HEAD
- STAINLESS STEEL VALVES
- COATED CERAMIC PISTON
- FLOW RATE VALVE
- PRESSURE REGULATION

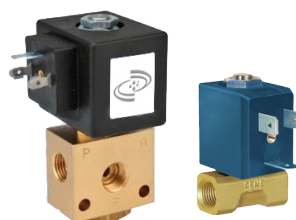

OPTIONAL DEVICES

- HIGH PRESSURE NO SOLENOID VALVE FOR WATER DRAIN
- LOW PRESSURE IN LINE NC SOLENOID VALVE
- SAFETY PRESSURE SWITCH
- STEEL PAINTED BLACK HANDLE FRAME



VIDEO



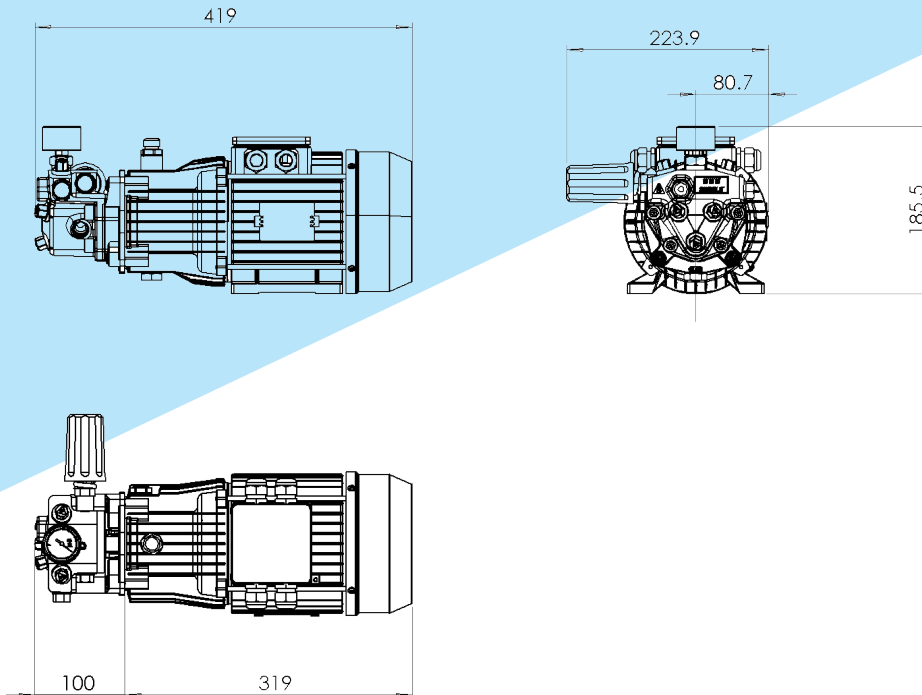

CE



## TECHNICAL DATA

- SIMMM pump AXA model with (CE approved)
- Patented flow rate valve (large range of nozzle numbers with the same model)
- Adjustable pressure up to 105 Bar
- Professional gauge
- Water seals in viton
- “H” class motor 6 pole low speed (900 rpm)
- Lowest noise level < 50 dB.

## OPTIONAL DEVICES

- High pressure NO solenoid valve for water drain
- Low pressure in line NC solenoid valve
- Safety pressure switch
- Steel painted black handle frame

## BENEFITS

Efficiency – Low speed 900 rpm motor with lower current consumption and longer reliability

Flexibility – Single pump with larger flow rate from few nozzle to large quantity

Expansion – Possibility to use more pumps in parallel for highest flow rate

Environmental – Lower motor speeds reduce operating noise and heat. Less power use is better for the environment.

Robustness – Brass head pump with ceramic piston and stainless steel valves

MODEL	AXA2.20	AXA5.40	AXA10.70	AXA50.100	AXA100.210
PRESSIONE (BAR)	70-150	70-105	70-105	70/105	70/105
NOZZLES NUMBER (0.2 MM)	20	40	70	100	210
PUMP	SIMMM AXA	SIMMM AXA	SIMMM AXA	SIMMM AXA	SIMMM AXA
MIN FLOW RATE (LT/MIN)	0.15	0.5	1	3.9	7.8
MAX FLOW RATE (LT/MIN)	1.7	3.5	5	7.8	18
MOTOR SPEED (RPM)	900	900	900	900	1.450
VOLTAGE (VOLT)	230/115 50/60 Hz.*	230/115 50/60 Hz.*	230/115 50/60 Hz.*	230/115 50/60Hz.*	230/115 50/60Hz.*
POWER (KW/H)	0.92	0.92	0.92	2.60	2.90
MAX DAILY USE (HOURS)	16	16	16	16	16
WEIGHT (KG)	36	36	36	36	36
DIMENSIONS LXHPX (CM)	32x19x24	32x19x24	32x19x24	32x19x24	32x19x24

\* ON REQUEST



# AXA VFD SERIES

AXAVFD10.60 | AXAVFD20.100 | AXAVFD20.400

Designed for industrial or commercial settings, the AXA VFD series misting pump provides accurate solutions for medium and large-sized environments. The patented mechanics with an axial cam, coupled with a high-efficiency pumping unit, are backed by electronic management facilitated through a soft-touch electronic board. AXA VFD is suitable for the simultaneous automatic management of both single and multiple zones.

The use of this product is therefore targeted at professional users requiring reliability, efficiency and continuity of operation for up to 16 hours per day.

10 YEARS  
GUARANTEE



### STANDARD FEATURES

- SOFT TOUCH PANEL
- CYCLING TIMER
- OVERLOAD ALARM
- OVERHEATING ALARM
- WATER LOSS ALARM
- WORKING TIME COUNTER
- REMOTE CONTACT

### PROFESSIONAL VARIABLE FREQUENCY DRIVE (VFD) WITH LARGE DISPLAY

- LOW VOLTAGE CONTROL
- MANAGED BY CPU

MANUAL PRESSURE  
REGULATOR

AXA SIMMM  
PROFESSIONAL PUMP

PROFESSIONAL PRESSURE  
GAUGE

### OPTIONAL DEVICES

- HIGH PRESSURE NC SOLENOID VALVE FOR WATER DRAIN
- LOW PRESSURE IN LINE NC SOLENOID VALVE
- SAFETY PRESSURE SWITCH
- STEEL PAINTED BLACK HANDLE FRAME

"H" CLASS HIGH EFFICIENCY  
ELECTRIC MOTOR 4 POLE IP54

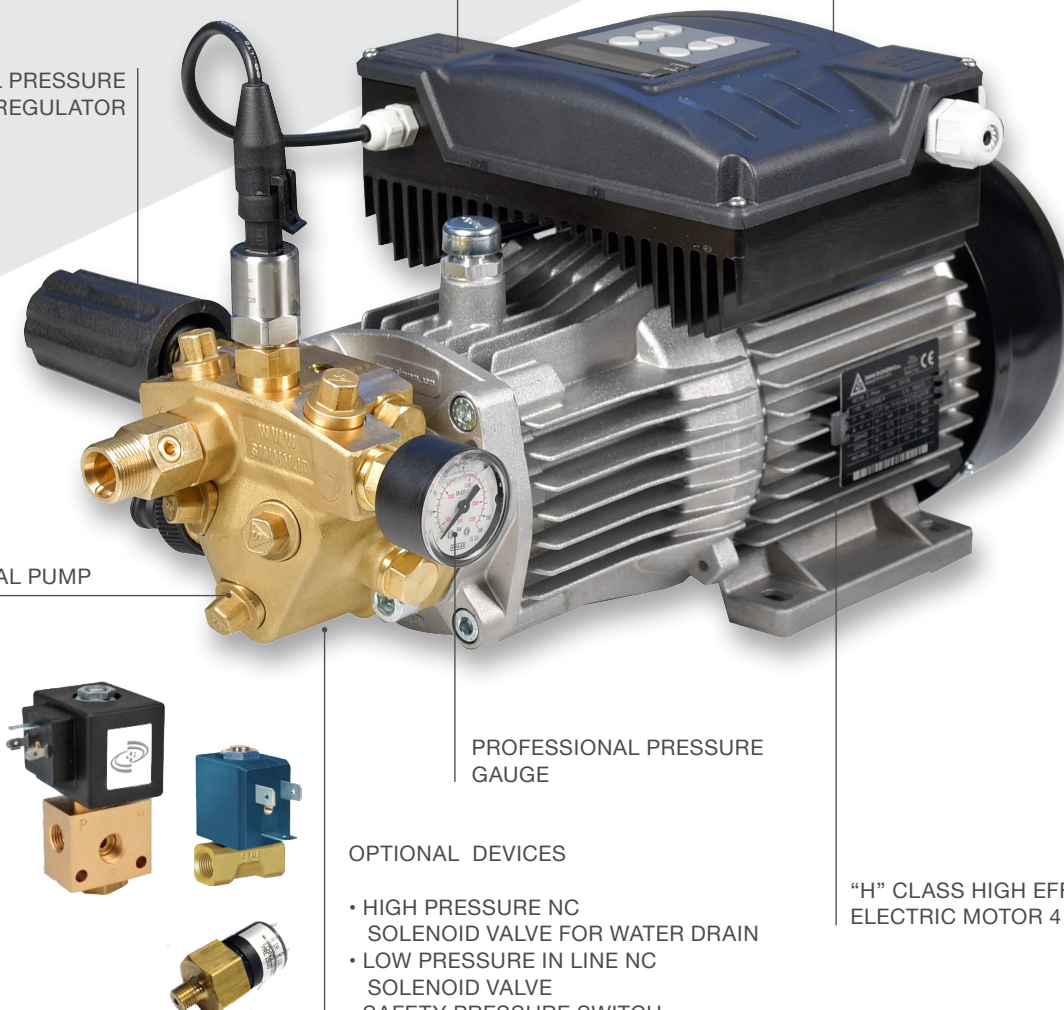

## BENEFITS

**Efficiency** – Uses standard 230V single phase power to operate a robust 3 phase motor for improved efficiency and cooler running

**Flexibility** – A single misting pump can cool multiple areas. The speed of the motor is automatically adjusted to maintain constant pressure across single or multiple zones.

**Expansion** – Additional zones can be added to an existing system without the cost of a new pump.

**Savings** – VFD systems generally operate at lower motor speeds than constant speed systems. Lower motor speeds mean reduced power consumption, reduced wear and tear, and lower maintenance costs.

**Environmental** – Lower motor speeds reduce operating noise and heat. Less power use is better for the environment.

**Robustness** – The inverter protects the pump from minor fluctuations in the power supply.

**Protection** – Inbuilt protection from high amperage, high temperature and loss of water supply.

## TECHNICAL DATA

- SIMMM pump AXA model with (CE approved)
- Patented flow rate valve (large range of nozzle numbers with the same model)
- Adjustable pressure up to 105 Bar
- Professional gauge
- Water seals in viton
- Professional VFD variable frequency driver
- Low voltage control panel managed by CPU
- “H” class motor 4 pole low speed (1.450 rpm)
- Lowest noise level 15 dB @ 10 Hz.



## STANDARD FUNCTIONS

- Soft motor start
- Cycling timer
- Overload alarm
- Overheating alarm
- Water loss alarm
- Working time counter
- Remote contact

## OPTIONAL DEVICES

- High pressure NC solenoid valve for water drain
- Low pressure in line NC solenoid valve
- Safety pressure switch
- Steel painted black handle frame



MODEL	AXAVFD10.60	AXAVFD20.100	AXAVFD60.250
PRESSURE (BAR)	70	70	70
NOZZLES NUMBER (0.2 MM)	60	100	250
PUMP	SIMMM AXA	SIMMM AXA	SIMMM AXA
MIN FLOW RATE (LT/MIN)	1.1	2.2	5.70
MAX FLOW RATE (LT/MIN)	4.68	8.2	20
MOTOR SPEED (RPM)	1.450	1.450	1.450
VOLTAGE (VOLT)	230/115* 50/60 Hz.	230/115* 50/60 Hz.	230/115* 50/60 Hz.
POWER MAX(AMPS)	3.3	3.3	9
MAX DAILY USE (HOURS)	16	16	16
WEIGHT (KG)	20	20	24
DIMENSIONS LXHXP (CM)	65x44x42	65x44x42	65x44x42



# REVERSE OSMOSI SERIES

07.821.A | 07.821.B

**How the Reverse Osmosis System Works?**  
Reverse Osmosis is a process in which dissolved inorganic solids (such as salts) are removed from a solution (such as water). This is accomplished by household water pressure pushing the tap water through a semi permeable membrane. The membrane (which is about as thick as cellophane) allows only the water to pass through, not the impurities or contaminates. These impurities and contaminates are flushed down the drain.

CONTROL PANEL

CARBON FILTER

PRESSURE PUMP

DOUBLE MEMBRANES (E300)  
IN SS ENCLOSURE

5 LT. WATER TANK

BOOSTER PUMP





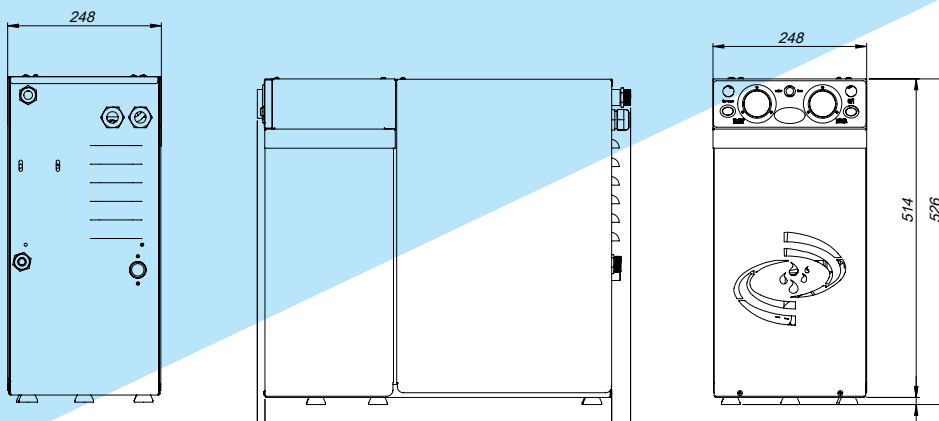

CE



## TECHNICAL DATA

- Cabinet in SS
- Professional Osmosis pump (10 bar)
- SS 5 lt water tank built-in
- 5 Bar booster pump
- Inlet carbon filter
- Membranes easy maintenance
- Auto-cleaning program
- Up to 300 lt/h (continuous) of pure water
- Electronic control panel
- Low voltage control panel (12 volt)
- Double pressure gauges
- By-pass function
- CE approved



MODEL	07.821.A	07.821.B
NO. MEMBRANES	1	2
WATER TANK	5 LT	5 LT
AUTO CLEANING PROGRAM	PRESENT	PRESENT
DIMENSIONS (MM)	248x560x526	318X557X583
WEIGHT (KG.)	19	25
SOUND LEVEL (DB)	<70	<70
TYPE OF INLET WATER	DRINKING WATER	DRINKING WATER
MIN. TEMPERATURE (°C)	5	5
MAX TEMPERATURE (°C)	45	45
TENSION (VOLT)	115/230 VOLT 50/60 HZ.*	115/230 VOLT 50/60 HZ.*
POWER (W)	426	800

\* ON REQUEST

# AXIAL FAN

07.456.5.A

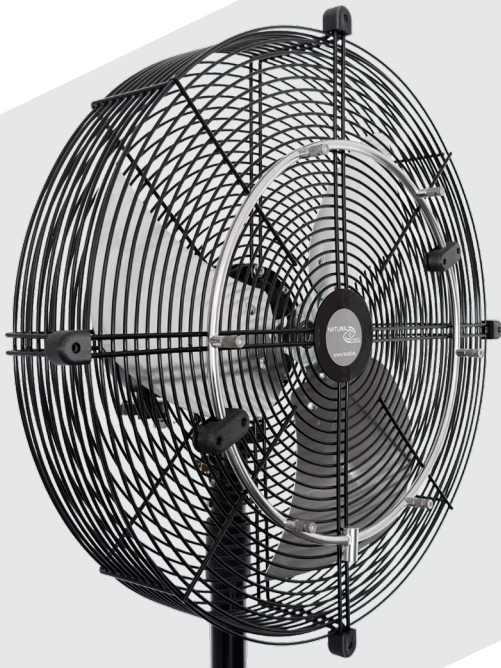

HIGH WEAR RESISTANT PROFESSIONAL FANS WITH THREE SPEEDS. A 4-BLADE METAL PROPELLER FOR STEADY AND SILENT OPERATION. OPERATING RANGE FOR INDOOR ENVIRONMENTS 12 M MAX AND 8 M FOR OUTDOOR. BLACK PAINTED STEEL GRILL. EQUIPPED WITH A HIGH-PRESSURE RING. IT SUPPORTS FIXED MISTING LINES WITH 1-6 MICROMETRIC NOZZLES. CAN BE POSITIONED TO A WALL OR FLOOR BRACKET AND CAN COVER SURFACES OF BETWEEN 40-70 SQM THANKS TO A 70° HORIZONTAL OSCILLATION. PARTICULARLY SUITABLE FOR INDUSTRIAL ENVIRONMENTS DUE TO THEIR HIGH RESISTANCE TO WEAR. CAN OPERATE FOR UP TO 16 HOURS A DAY.

A USEFULL COVER IS INCLUDED FOR WINTER PERIOD.



SPEED	ONE	TWO	THRE
SIZE (CM)	56	56	56
NOZZLES NUMBER	6	6	6
MOTOR SPEED (RPM)/SOUND LEVEL (DB)	1.000/31	1150/35	1.400/38
POWER (W)/IP RATE	310/IP65	330/IP65	350/IP65
VOLTAGE (V)	230-50 HZ.	230-50 HZ.	230-50 HZ.
OSCILLATION	70°	70°	70°
AIR FLOW (M3/H)	9.900	10.900	12.800

# ELIMIST

07.684.A

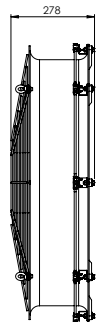
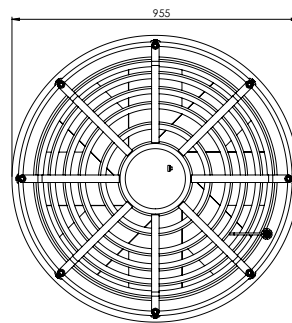

HIGH CAPACITY DESTRATIFIER COMES ACCOMPANIED BY A HIGH PRESSURE RING WITH A MAXIMUM OF 8 NOZZLES. CAN BE SUSPENDED ANCHORED TO THE CEILING AT A HEIGHT OF 4.0 M. AREA COVERAGE OF 70.0 SQ.M. APPLICABLE TO PROFESSIONAL HUMIDIFICATION SOLUTIONS TO SATISFY HIGH VOLUME AND LARGE SURFACE DEMANDS. FOR USE IN HIGH-VOLUME INDUSTRIAL ENVIRONMENTS AND CEILING HEIGHTS EQUAL TO OR GREATER THAN 5.0 M.

SIZE (CM)	90
NOZZLES NUMBER	8
MOTOR SPEED (RPM)	450
POWER (W)	520
VOLTAGE (V)	115/230-50 /60 HZ*
OSCILLATION	/
AIR FLOW (M3/H)	9.000

\* ON REQUEST



# TANGENTIAL FAN

07.724.B

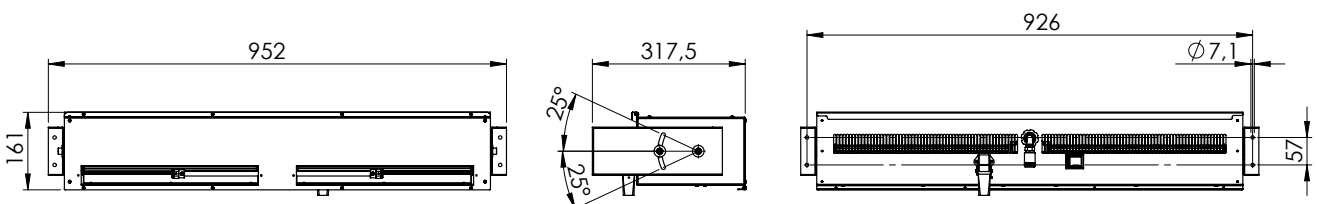
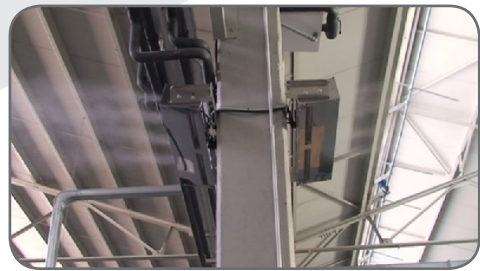

NOZZLES NUMBER	
MOTOR SPEED (RPM)	1.000
POWER (W)	45
VOLTAGE (V)	115/230-50/60 HZ.*
OSCILLATION	/
AIR FLOW (M3/H)	425

\* ON REQUEST





# SKY MIST

07.778.B



STIANLESS STEEL  
AISI 304

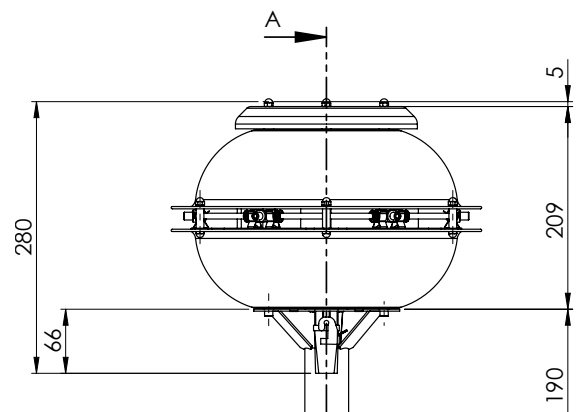
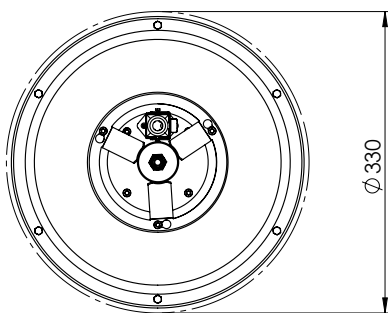

SIZE (CM)	35
NOZZLES NUMBER	6
MOTOR SPEED (RPM)	2,350
POWER (W)	52
VOLTAGE (V)	115/230-50/60 HZ*
OSCILLATION	/
AIR FLOW (M3/H)	540

\* ON REQUEST

# MIST 360° THE SOLUTION FOR ARMSIDE UMBRELLA



07.885



VIDEO



MIST360 IS THE NEW REVOLUTIONARY ACCESSORY FOR COOLING UNDER UMBRELLAS WITH SIDE ARM, GUARANTEEING UNIFORMITY AND TOTAL MISTING QUALITY.

COMPARED TO TRADITIONAL PRODUCTS IT IS VERY EASY TO INSTALL AND THE UMBRELLA CAN BE CLOSED AND OPENED EASILY WITHOUT CREATING INCONVENIENCE OR WASTING TIME. THE MODULARITY OF THIS ACCESSORY ALLOWS THE EASY ADDITION OF MIST 360 EVEN ON UMBRELLAS INSTALLED LATER.

MIST360 IS THE FUNDAMENTAL ACCESSORY FOR ALL THOSE COMMERCIAL ESTABLISHMENTS SUCH AS RESTAURANTS, BARS, PIZZERIAS,





## CONTACT US

---



IMTEC s.r.o.  
Kadnárova 19  
83152 Bratislava / SK



+421 905616753  
+420 774260844



imtec@imtec.sk

[www.imtec.sk](http://www.imtec.sk)  
[www.imtec.cz](http://www.imtec.cz)  
[www.imtecshop.com](http://www.imtecshop.com)

NATURAL  COOL

A division of SIMMM Engineering srl